

OLD!

THE ESSENTIAL GUIDE TO CLASSIC GAMES

# retro GAMER

AMSTRAD | SEGA | NINTENDO | ATARI | SINCLAIR | MEGADRAMA | SONIC

## ELLIPSE 30-YEAR SPECIAL

DAVID BRABEN ON: EVERY GAME, ITS IMPACT & LEGACY  
PLUS: INDUSTRY GREATS REMEMBER THE CLASSIC GAME

“FIGHTING IN 3D  
ACTUALLY FELT  
GREAT. IT FELT  
DIFFERENT.”  
Braben on the move to 3D



+ TOP 25  
MASTER  
SYSTEM  
GAMES

CONTRA:  
HARD CORPS  
IS KONAMI'S MEGA DRIVE BLASTER  
WORTH ITS HIGH ASKING PRICE?

ALSO INSIDE NUTTING INDUSTRIES • ARCHER MACLEAN • ALIEN BREED • BLOOD  
PUZZLE BOBBLE • MAD PLANETS • MICROVISION • RANARAMA • AMIGA 1200

**ip** DigitalEdition  
IMAGINE PUBLISHING GreatDigitalMags.com  
ISSUE 136

# funstock.co.uk

## Christmas Gift Guide

visit [www.funstock.co.uk/retrogamer135](http://www.funstock.co.uk/retrogamer135)

JXD Android Retro Gaming Tablet

£124.99



The JXD S7800b is an Android retro gaming tablet. It is capable of playing even the most complex of retro games, including PS1, N64, MAME and Dreamcast and capable of displaying these on your TV via HDMI.

SNK NeoGeo X Gold  
21 NeoGeo Games included

£99.99



The SNK NeoGeo X is a handheld Neo Geo games console with 20 built-in original NeoGeo AES games. The Gold Limited Edition package comes with an authentic arcade stick and AES style docking station to connect to your TV.

Commodore 64 Book  
A Visual Compendium



A book celebrating the visual side of the glorious Commodore 64 (aka C64) computer and games. Each spread features a beautiful image and a select few words from original developers, journalists, artists and more...

£24.99

Super Retro Trio  
3 in 1 Retro Console  
MegaDrive, NES, SNES

The Super Retro Trio plays Nintendo NES games, Nintendo SNES games and SEGA GENESIS / SEGA MEGA DRIVE games directly from the original retro game cartridges!

£74.99



SEGA Wireless  
80 Games Included



A 2 player SEGA Mega Drive console with 80 built-in SEGA games (including Sonic the Hedgehog 1 + 2). You can also use original SEGA Mega Drive games / SEGA Genesis games and cartridges from all regions!

£44.99



Atari Bag



Officially licensed Atari dark red Atari messenger bag for people on the move. Show your love for Atari and keep all your things secure all at the same time.

£29.99



Street Fighter Monopoly

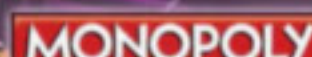

Officially Licensed Street Fighter Collector's Edition version of the Monopoly board game!

£34.99



SEGA Ultimate



Sonic the Hedgehog Special Edition version of the SEGA Ultimate retro video games console. 20 built-in classic SEGA Mega Drive games and SD card slot!

£39.99



### THE RETROBATES

QUITE MATURE THEM GAME



**DARRAN JONES**  
California Games for me. I have fond memories of beating all my friends at the surfing event.  
**Expertise:** Juggling a beautiful wife, two gorgeous girls and an award-winning magazine.  
**Currently playing:** Castlevania: Bloodlines  
**Favourite game of all time:** Strider



**NICK THORPE**  
I could try to not look like an obsessive fan here, but let's be honest - it's Sonic.  
**Expertise:** Coin-ops, Sega hardware and everything Nineties.  
**Currently playing:** Pokémon Alpha Sapphire  
**Favourite game of all time:** Sonic: The Hedgehog



**PAUL DRURY**  
I'm no Master System connoisseur but I was impressed by its version of Sonic 2 and the dependably entertaining Wonder Boy series.  
**Expertise:** Christmases past  
**Currently playing:** Driveclub  
**Favourite game of all time:** Sheep In Space



**JONATHAN WELLS**  
I didn't own a Master System growing up but I remember playing Shinobi round a friend's house... once... maybe?  
**Expertise:** Tackling dirty nappies and retro spreads  
**Currently playing:** Destiny  
**Favourite game of all time:** The Secret Of Monkey Island



**DAVID CROOKES**  
It's got to be Sonic for me. It was different in the Master System but no worse for it and very much a classic.  
**Expertise:** Amstrad, Lynx, adventures, Dizzy and PlayStation (but is that retro? Debate!)  
**Currently playing:** Prince Of Persia  
**Favourite game of all time:** Broken Sword



**PAUL DAVIES**  
R-Type. It blew me away, though I was always shit at it.  
**Expertise:** Repeatedly banging my head against a brick wall  
**Currently playing:** Halo: The Master Chief Collection  
**Favourite game of all time:** Ghouls 'N' Ghosts



**JASON KELK**  
I'm a shoot-'em-up fan, so it has to be R-Type really... Although I have a soft spot for Astro Warrior too.  
**Expertise:** Indie, homebrew and bedroom-coded games.  
**Currently playing:** Humanoid (Atari 8-bit)  
**Favourite game of all time:** Io



LOADING

LOADING

**W**here's the Christmas cover? It's something we'll certainly be returning to in the future, but we wanted to take this opportunity to support the 30th anniversary of one of the UK's most significant 8-bit games - Ian Bell and David Braben's *Elite*.

I can remember my first *Elite* encounter as if it was yesterday. I had gone around to see Andrew Joiner, who was unfortunate enough to own a BBC Micro. I say unfortunate, because we'd all take the mickey out of him at school as he had the same computer we used for our schoolwork. It was Andrew who had the last laugh, however, as he owned *Elite* and it was really quite awesome. While I didn't personally like playing *Elite* (it was far too fiddly for me), I could sit and watch him explore in that game for hours, occasionally taking over for the epic dogfights it offered. There's an amazing sense of wonder in *Elite* that many games of the time just couldn't compete with. The visuals looked incredible, making you feel like you were in the Millennium Falcon, or taking over the bridge of the Enterprise. I'm hoping that the incoming release of *Elite: Dangerous* will ignite those very same feelings I had 30 years ago.

Enjoy the magazine,





# Is Satoru Iwata gaming's greatest icon?

“For young players, classic games are brand new. For older players, they bring back memories and make you feel good”

Satoru Iwata

**W**ith the new generation of games hardware now in full swing, we felt it was the perfect time to celebrate some of gaming's biggest icons for an exciting upcoming feature.

Help **Retro Gamer** find the many important individuals who have turned our favourite pastime into one of the world's biggest forms of entertainment, so that we can give them the recognition they deserve in a future issue. Whether you believe it was Shigeru Miyamoto who refreshed the gaming landscape, or that Nolan Bushnell heralded the start of the videogames industry as we know it, we'd love to have your input. As always, the best suggestions will appear in the magazine, so take this opportunity to join in the celebrations and have your say.

You can tell us about your favourite industry veterans on the **Retro Gamer** forum, our Facebook page, or even via Twitter using **#videogameicons**.

We look forward to your suggestions...



BALLOON FIGHT

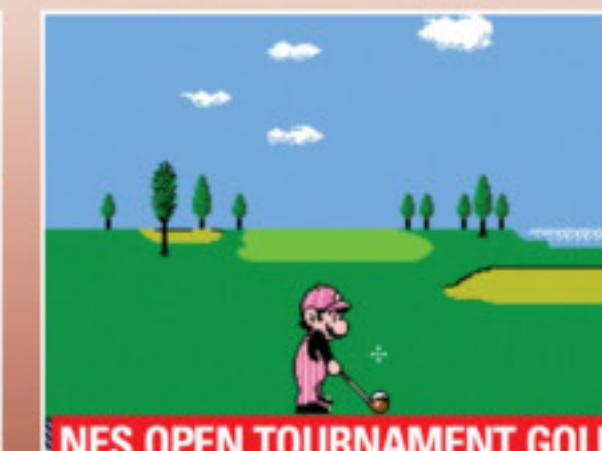

NES OPEN TOURNAMENT GOLF



KIRBY'S ADVENTURE



EARTHBOUND



POKÉMON STADIUM

**CONTACT US NOW!**

What's your favourite Satoru Iwata game? Let us know

RetroGamerUK @RetroGamer\_Mag

retrogamer@imagine-publishing.co.uk

www.retrogamer.net/forum

>> Load 136 Breathing new life into classic

Don't forget to follow us online for all the latest retro updates

f RetroGamerUK @RetroGamer\_Mag retrogamer@imagine-publishing.co.uk

**SUBSCRIBE TODAY!** AND SAVE 50%  
In space no one can hear you save money  
Subscribe at [www.imaginepubs.co.uk](http://www.imaginepubs.co.uk)



## The Making Of Ranarama

Rory Milne uncovers the sorcery behind Graftgold's classic action RPG

34

## RETRO RADAR

### 08 Play Expo

Gordon Sinclair looks back at this year's impressive gaming event

### 10 News Wall

We look at a brand new computer museum and Rocket Ranger Reloaded

### 12 Paul Davies

Paul discusses repetition in videogames

### 14 The Vault

Some last-minute gift ideas for the retro fan in your life – or maybe yourself

### 15 Collectors Corner

We show off another gathering of gaming goodness to make you green with envy

### 16 A Moment With Mike Diskett

The former Bullfrog coder talks about his new project *Satellite Reign*

### 18 Back to the 90s

Richard Burton's regular return to the past takes him to November 1997

## REVIVALS

### 20 Reader Revival: Zombi

David Skillins takes a look back at Ubisoft's unofficial film tie-in

### 32 Retro Revival: Deflektor

Grenlin's beam-bending puzzler stretches Nick's brain

### 60 Retro Revival: Alien Breed

Darran explains why swapping his SNES collection for an Amiga 1200 wasn't all bad

## 30 years of: Elite

We celebrate three decades of the groundbreaking space trading series

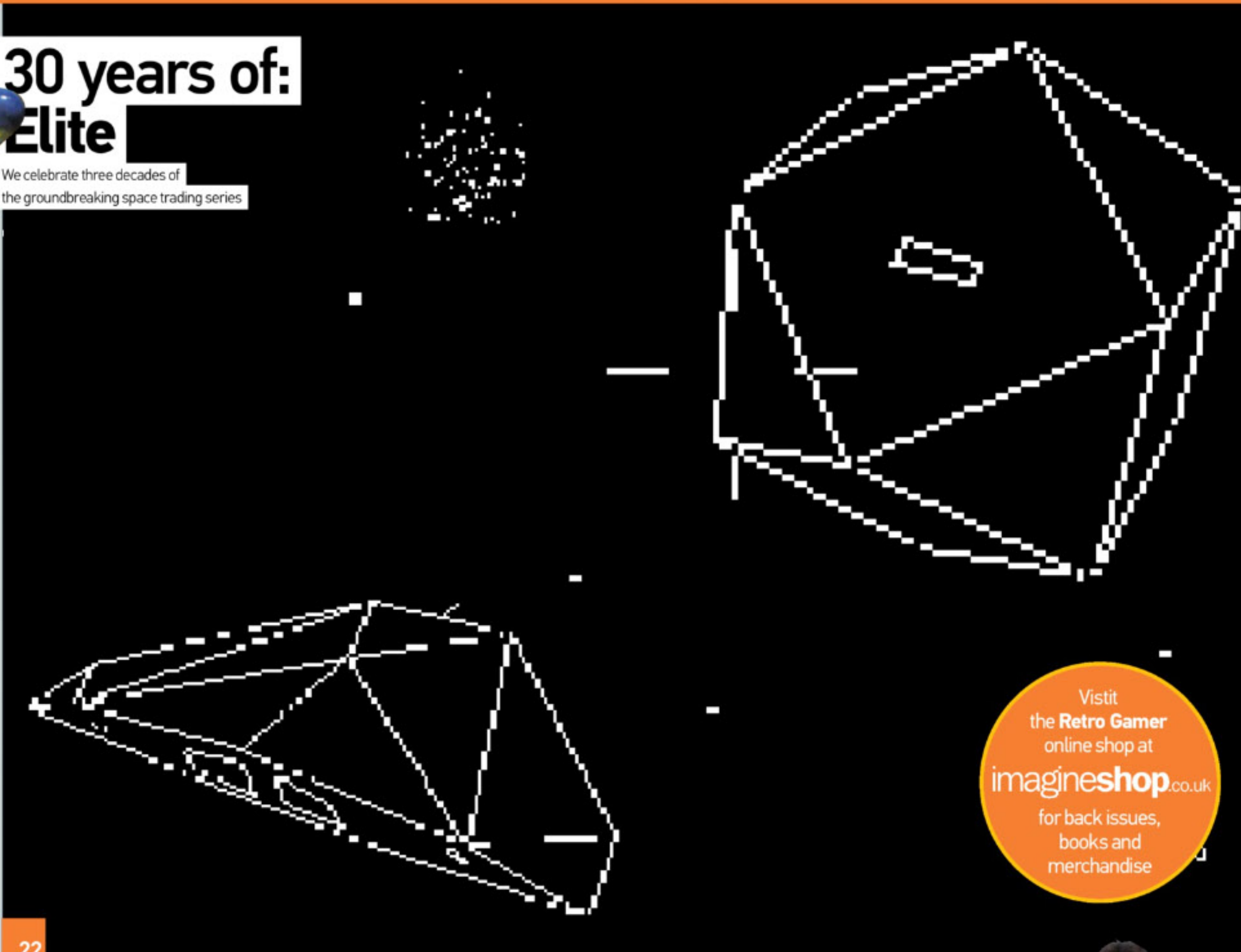

22

Visit the **Retro Gamer** online shop at [imagineshop.co.uk](http://imagineshop.co.uk) for back issues, books and merchandise

### 98 Retro Revival: Ape Escape

Never let it be said that we spend our time monkeying around

## FEATURED

### 38 The Best Gifts Ever!

Developers tell Paul Drury about their favourite memories of the festive season

### 40 Ultimate Guide: Puzzle Bobble

Bub and Bob swap platforming for puzzling in this classic arcade release

### 46 Import Only: Cool Cool Toon

We look back at an uncharacteristic cartoonish rhythm-action release from SNK

### 48 Minority Report: Amiga 1200

Planning on picking up Commodore's computer? Make sure you get these gems

### 52 Classic Moments: Cauldron

Revisit the best bits of this bewitching arcade adventure

### 54 Lost in Translation

In a new series, Nick Thorpe investigates the games that have issues crossing borders

### 70 The Making Of Blood

Graeme Mason reveals the creativity behind the carnage of 3D Realms' first-person shooter

### 76 35 Years of Microvision

Marty Goldberg looks back at this increasingly hard-to-find electronic handheld

### 84 The Making Of Mad Planets

It might not be as well known as *Asteroids*, but *Mad Planets* has a story that's still worth telling



62

## Top 25 Master System Games

We look at your favourite games for Sega's console. What have you played?



74

## My Gaming Memories: Archer Maclean

The *Dropzone* designer reminisces about the heyday of arcade games

### Retro Inspired: Volgarr The Viking



90

### From The Archives: Nutting Industries



92

“An amazingly memorable moment, from a game packed full of memorable moments”

## Classic Moments Contra: Hard Corps

Is this a better game than *Alien Wars*? These amazing bits may help change your mind



82

## REVIEWS

### 100 Toybox Turbos

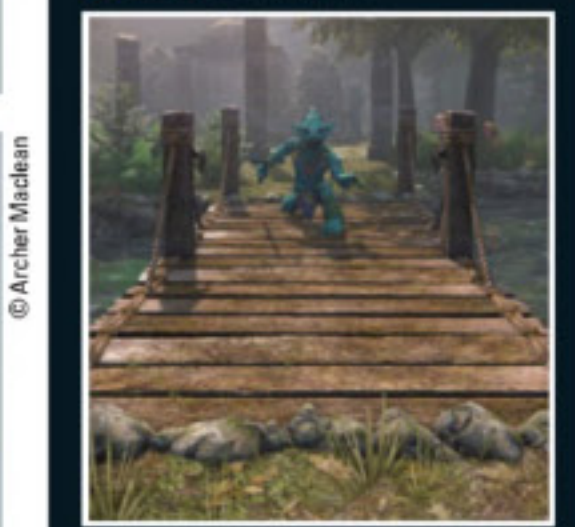

- 102 Legend Of Grimrock II
- 102 Pokémon Alpha Sapphire / Omega Ruby
- 102 Wings: Remastered Edition
- 102 Halo: The Master Chief Collection

## ESSENTIALS

- 88 Subscriptions  
You can search the galaxy and never find an offer that's this good
- 104 Homebrew  
Jason Kelk brings you all the latest games on older platforms
- 108 Mailbag  
You write, we reply, and someone wins a prize!
- 111 Next Month  
There's no need to buy a hint – here's what's coming in issue 137
- 114 End/Game  
We try to provide an abridged version of *Metal Gear Solid*'s dialogue



# PLAY EXPO – BIGGER, BETTER AND BOLDER

GORDON SINCLAIR ON THE BIGGEST RETRO EVENT YET

## \* CONTENTS

### 8 PLAY EXPO – BIGGER, BETTER AND BOLDER

We chat to co-organiser Gordon Sinclair about the popular gaming event

### 10 NEWS WALL

Find out about a new game museum and the return of some classic LucasArts games

### 12 PAUL DAVIES

This month, our favourite columnist discusses the merits of repetition

### 14 THE VAULT

Looking for great gifts to buy for Christmas? Then check these out

### 15 COLLECTORS CORNER NEW!

Stephen Bowler tells us how he has amassed 4,500 videogames

### 16 A MOMENT WITH MIKE DISKETT

The lead designer on Sydicade Wars tells us about his spiritual sequel

## Replay Events' Play Expo returned to Manchester's Event City on 11-12 October and lived up to its promise of

even more in the way of entertainment for attendees. As well as the usual Replay section, chock full of consoles and computers, and the popular vast array of arcade and pinball machines, this year's expo saw the debut of the screen.play zone where various exhibits and items from cinema and television were displayed. Highlights of this zone included two shiny Transformers (which sadly remained in car form), a replica DeLorean from *Back To The Future* and the motorbike and sidecar from the third Indiana Jones movie, *The Last Crusade*. In addition, there were special appearances from stars of both film and the small screen: Dave Prowse, Jeremy Bulloch and Kenny Baker were flying the flag for *Star Wars* while that loveable duo, Chris Barrie (Arnold Judas Rimmer) and Craig Charles (Dave Lister) from classic sci-fi comedy *Red Dwarf* gave autographs and posed for photos on their respective days at the expo.

Once more the selection of talks proved varied and entertaining and it

was pleasing to see all the issues from previous shows ironed out. Perhaps the most interesting to *Retro Gamer* was the ZX Spectrum vs Commodore 64 debate, hosted by our very own Paul Drury with technical assistance from fellow freelancer Martyn Carroll. Called in to discuss the relative merits of each machine were Jeff Minter and Andy Walker for the Commodore 64 and John Gibson and Ste Pickford for the Spectrum. After a fierce discussion, the vote was put to the audience and an honourable (if slightly dubious) draw was declared. The other talks, including industry legends such as Mel Croucher (Automata), Charles Cecil (Artic, Revolution) and Cinemaware, were also very popular with attendees.

At the end of an inevitably quieter Sunday, *Retro Gamer* managed to catch up with Replay Events' Gordon Sinclair to ask him about the new elements to the Expo. "Every year the show gets bigger and this year we are also working with new communities such as The Retro Computer Museum," said a remarkably calm Gordon considering the stress and effort that he and the Replay Events team put



• The arcade area was once again filled with people and had a fantastic selection of games to play.



• There was an impressive selection of interviewees, including Charles Cecil and Mel Croucher.



• Cosplay remains extremely popular, with some superb costumes on show.

## READERS WEIGH IN

### WHAT DID YOU THINK OF PLAY EXPO?

■ "The event was awesome! The retro section was huge: there was a great selection of 8- and 16-bit computers and consoles, arcade and pinball machines, as well as the newer consoles. It was also great to finally meet up with and chat to Chris Barrie and Craig Charles after Special FX working on Series 1 *Red Dwarf* computer displays, although I was always a big fan of the show anyway."  
**JIM BAGLEY**

■ This was my third Play Expo in Manchester and it has always been really friendly and an opportunity to chat to like-minded people... and I thought the selection of coin-ops this time around was fantastic.  
**LEIGH HILLS**

■ I thought it was easily their best yet. The retro section was far better set out and it was good to see them expand this rather than let modern gaming take over the event. Still a few niggles to sort out: the linked PCs were obviously not run by the event, but they need to work with the organisers better as this is the second year they failed to get systems up and running until well into the first day.  
**MARK AMBROSE, AKA MARKOPOLOMAN**

■ Really enjoyed the amount of computers and consoles this year. Loved the selection of arcade machines, especially the hydraulic *OutRun* and *After Burner* cabs. Glad they had a working *Tron* machine, and that I finally got to have a go at it!  
**MIKE WILCOX, AKA JETSETWILLY**

■ I thought it was one of the best events we have ever been part of. The social aspect was immense. So many friends both old and new. It was a massive event with the feel of something much smaller.  
**RETRO COMPUTER MUSEUM'S ANDREW SPENCER**



• There were lots of stalls selling goods with very competitive prices.

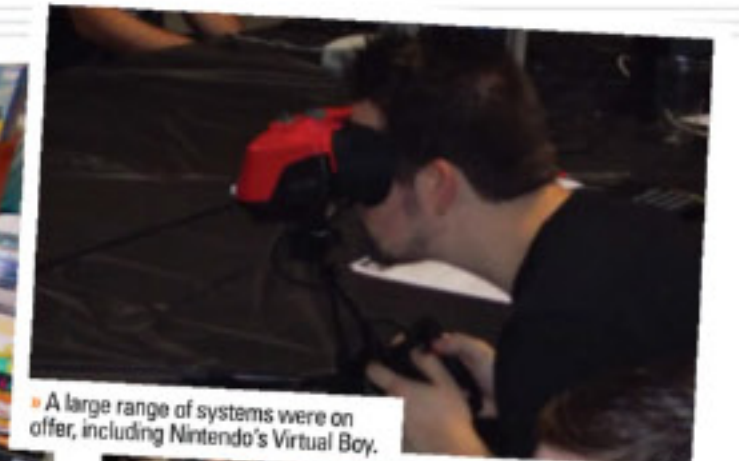

• A large range of systems were on offer, including Nintendo's Virtual Boy.

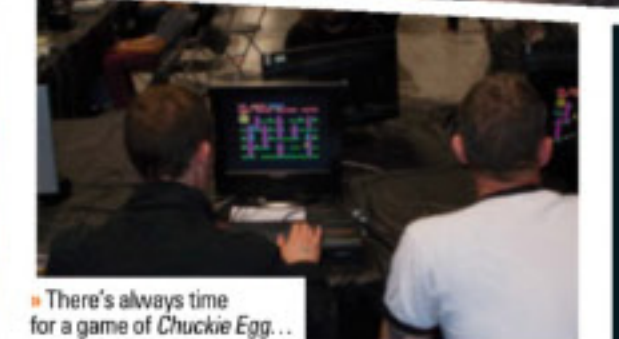

• There's always time for a game of Chuckie Egg...

into Play Expo. "And given the show is about all aspects of gaming, we feel the balance is pretty good this year." Even screen.play was not totally detached from gaming, with the expo offering ten individual movie celebrations with key games from the movies on display. However, the Indie Zone, with its eclectic mix of retro-themed modern games, was one of the most popular areas, with the fantastic 2D brawlers *Raging Justice* and *Wulverblade* attracting the most attention, the latter walking away with the People's Choice Award for best indie game at the show.

The event also saw the conclusion of the Classic Gaming Championships (CGC), the UK's first ever national championship for retro gaming, and one that has been running for the past few months at various locations up and down the UK. "That's the thing I'm most proud of," says Gordon, "as we've had heats as far afield as London, Cardiff and Glasgow with over 1,000 people taking part." All ten heat winners were present at Manchester as they battled it out in a grand final, which was won by Gavin Ward of Rochdale, who was subsequently crowned 2014 Classic Gaming Champion.



• Darran's really regretting missing this year's show. He loves *Salamander*.

## HIGHLIGHTS

>> Our favourite bits from Play Expo 2014



### SCREEN.PLAY

■ New for 2014, this vibrant zone included famous movie props, two Transformer cars (Autobot Bumblebee and Decepticon Barricade) and the iconic DeLorean from *Back To The Future*. Exhibits on the relative videogames tied things up nicely while fans chatted to stars of screen such as Dave Prowse (Darth Vader) and Craig Charles from *Red Dwarf*. Attendees could also have their photo taken on a *Game Of Thrones* chair.



### PINBALL CRAZY

■ The vast selection of pinball tables at the Play Expo have always been popular with attendees, and this year was no exception. With them all set to freeplay (like their arcade counterparts) and, as far as we could tell, players generally condescend with their credits, the tables were another success. The presence of Gary Stern, of the famous pinball manufacturer of the same name, was also a delight for fans.



### ZX SPECTRUM VS COMMODORE 64

■ It's one of the oldest gaming playground arguments and this year's Play Expo tried to settle it. With Ste Pickford (Binary Design) and John Gibson (Imagine) representing the Spectrum versus Andy Walker (Taskset) and Jeff Minter (Llamasoft) the C64, a heated discussion took place about the relative merits of each computer. Incredibly, they received an equal number of attendee votes.

The success of this and an overall attendance of 20,000+ people has all but guaranteed that Play Expo will return next year. Says Gordon: "Play Expo is firmly on the events map now and I think a lot of people would be disappointed if it didn't return. We will listen to the feedback we get through social media and try to accommodate as much as we can in terms of improving the experience for everyone." One area that still needed a bit of work was the queues to get into the venue on the Saturday morning, as Gordon admits. "There are still things to improve on queueing, and they were bigger than ever this year as it seems everyone wanted to be in as soon as we open! But we feel they were

managed better and cleared quicker than in previous years." Overall, despite the presence of a mind-boggling array of games and movie-related merchandise and an ever-increasing range of zones, Play Expo was again an enjoyable event, boasting plenty of gaming action for the current gen (over 100 PS4 consoles), the indies (30+ games from 25 studios) as well as the mass of retro goodness in the Replay section. We finished by asking Gordon what lies ahead for Replay Events. "Play Blackpool is less than six months away, so we're now cracking on with that, and also supporting other events around the country such as Platform Expo, GEEK and EGX. Life is never dull in the events game." \*

“Every year the show gets bigger and this year we are also working with new communities” Gordon Sinclair



GameCity has years of experience in providing visitor attractions, thanks to its annual festival.

## GAMECITY TO OPEN UK VIDEOGAME MUSEUM

£2.5 MILLION PROJECT TO OPEN IN 2015

GameCity has announced the opening of the National Videogame Arcade, a project it describes as "the world's first cultural centre for gaming." The Nottingham-based museum, which has attracted funding of £2.5 million, is set to open in March 2015. The group made the announcement at the ninth annual GameCity Festival. Other museums in the UK have included videogames as a key part of their collections and exhibitions, such as the Museum Of Computing in Swindon and the Centre For Computing History in Cambridge, but the National Videogame Arcade is the first to be dedicated solely to videogames.

The launch of the National Videogame Arcade coincides with the tenth anniversary of GameCity, which has been working to promote videogame culture since 2005. The GameCity Festival is its most major achievement, bringing together a programme of events, workshops and exhibitions in Nottingham each year. GameCity team members were also instrumental in setting up the National Videogame Archive, in conjunction



The attractive exhibition design of the GameCity Festival should provide a good blueprint for the National Videogame Arcade's exhibitions.

with the Science Museum and Nottingham Trent University. The latter is one of the main organisations funding the National Videogame Arcade, alongside Nottingham City Council, the Nottingham Technology Grant Fund and the Confetti Institute Of Creative Technologies.

The National Videogame Arcade itself is to occupy 33,000 square feet of space across five floors. Four of these are designated as gallery floors to host exhibitions on all aspects of gaming, which will be updated quarterly. This includes a permanent exhibition of items from the National Videogame Archive – an enormous collection of over 12,000 items including unique prototype and development material as well as the hardware and software that made your childhood. The remaining floor is set aside as a permanent educational space, to provide lessons in game development to students of all ages. For more information on the National Videogame Arcade, visit [www.gamecity.org](http://www.gamecity.org).



This building on Nottingham's Carlton Street is the future home of the National Videogame Arcade.

## ROCKET RANGER HEADS TO KICKSTARTER

Following the success of Cinemaware's Kickstarter campaign for *Wings: Remastered Edition*, the publisher has now announced an update of its popular hit *Rocket Ranger* that is currently available to back on the crowdfunding service. The campaign for *Rocket Ranger: Reloaded* is looking good so far with \$29,665 of its \$89,999 target currently raised. Unlike *Wings: Remastered Edition*, which was more or less an updated version of the original, *Reloaded* promises brand new content that ranges from enhancing the story to adding new weapons, items and characters. Visit [www.kickstarter.com](http://www.kickstarter.com) for more info.



## LUCASARTS CLASSICS RETURN TO RETAIL

Online retailer gog.com recently struck a deal with Disney Interactive to add a selection of classic LucasArts titles to its store, ensuring that the classic developer's PC games will continue to be available to owners of modern computers. The major announcement was the return of two much requested Nineties PC titles, the *Star Wars* games *X-Wing* and *Tie Fighter*. *Indiana Jones And The Fate Of Atlantis*, *Star Wars: Knights Of The Old Republic*, *Sam & Max Hit The Road* and *The Secret Of Monkey Island: Special Edition* also joined the service, as more obvious choices which will doubtless please fans.

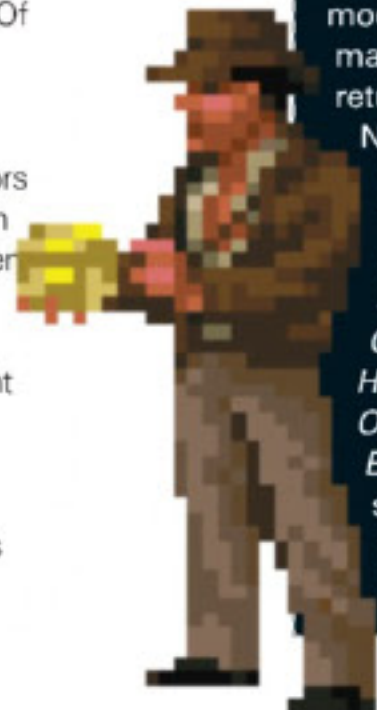

## THE UNTOLD HISTORY OF JAPANESE GAME DEVELOPERS

36 interviewees, 526 pages, over a quarter of a million words, with more undocumented information than any other source. Dozens of unreleased games, Konami and Namco and Taito's unreleased home consoles, the sneaky politics behind Enix's early years, the pre-history and founding of Game Arts, plus the unheard secrets of Telenet, Falcom, Quintet, SNK, Sega, Hudson, Namco, Capcom, Mitchell Corporation, Love-de-Lic, and more, straight from those who were there. Features hand-drawn office layouts from these classic developers, plus never before seen archive photographs, all documenting the last 35 years of Japanese gaming history.

"The most important book on video games since Game Over. Retro fans will still discuss this in one hundred years." - Game Preservation Society

"John Szczepaniak is the David Attenborough of Japanese games." - Amazon

"We now have a window into Japanese development and its history, where previously there was only hearsay." - Forbes

Available in print and Kindle format, exclusively on:





Here's my bio... Paul Davies

In 1992 I started out on *Mean Machines*, *Sega* and *Nintendo Magazine*. In 1995 I became editor of *C&VG*. I led the *C&VG* website from 1998 until Christmas 2000, then I left journalism to be concept design manager at Criterion Games. I returned to journalism in 2002 and from 2005 I've been running my own company, Unlikely Hero.

“It's human nature to enjoy exactly the same thing over and over again”



## Joy of repetition

**H**alo was described by designer Jaime Griesemer as: “30 seconds of fun that happened over and over again.” I'm going to suggest that every great game

amounts to the same thing. I also think this is broadly speaking awesome for an honest handful of reasons.

It's human nature to enjoy something, indeed exactly the same thing, over and over again. I'm not smart enough to go deeply into this, and I'd be testing your patience to even try. All I can do is point to music, movies, sport and... you name it really, and the repetition thing is right there for all to see.

In football it's the pass and go, in music the familiar phrase. It's said that there only seven basic plots that fuel hundreds of books and movies, for which we'll happily guess the outcomes. And all of this makes me feel so much less guilty about sinking so many hours into *Pac-Man*, *Chuckie Egg*, *Defender*, *Robotron*... and on and on. You know, grinding in loot games is absolutely nothing new. I've been grinding gaming scenarios since the very early days. Admittedly I was

doing so for nothing other than personal satisfaction and equally nothing to show.

Currently I am repeatedly playing through the same missions, strikes and raid of Bungie's *Destiny* that shipped at launch. I don't need to believe anything that's going on in terms of story, I'm just having a blast figuring out then stomping all over the patterns that emerge, just like I used to tackle *Galaga* and *Gorf*. The same principles apply to the multiplayer arena, perfecting (as best I can) a route around a handful of locations that I nervously exploit. Benefits I gain here are interchangeable with *Call Of Duty*, *Battlefield*, *Halo* and whichever else FPS happens along next.

Doing something over and over is the thing that appears so mindless to, um, 'outsiders' – people who just don't game; though as I mentioned last issue, the numbers are rapidly falling. The next level of unacceptable is what could be perceived as addiction, but for actors, musicians or professional sportsmen and women the hunger to perfect an art form is most admirable when it's insatiable.

So, look where we just arrived. By facing up to what's arguably the most unattractive element of the gaming pastime since *Pong* or Atari *VCS Combat*, we've found what makes it strong. The repetition is another validation of games as art. Repetition is at the root of the steamrolling League of Legends World Championship, where spontaneity erupts from a foundation of relentless practice routines: hammering out the kinks of the smaller components so that they're not hindering the goals. In the same way, a tournament-level fighter will spend hours rehearsing eg Akira Yuki's Stun Palm to make it available in the split second that it is required. And in that moment the performance can be mind-blowing for an audience appreciative of the hurdles involved.

To me, that comment from Griesemer (now at Sucker Punch) is priceless as a way of understanding what makes the best games tick. Hopefully you're better at formulating points for discussion than I am, and the joy of repetition regarding games is something fascinating to share around. \*

### What do you think?

Do you agree with Paul's thoughts? Contact us at:

RetroGamerUK 
 @RetroGamer\_Mag 
 retrogamer@imagine-publishing.co.uk 
 www.retrogamer.net/forum

# HALO

THE MASTER CHIEF COLLECTION



4 BLOCKBUSTER GAMES ON 1 DISC

EXCLUSIVE ACCESS TO HALO 5: GUARDIANS MULTIPLAYER BETA

100+ MULTIPLAYER MAPS

INCLUDES HALO: NIGHTFALL DIGITAL SERIES

OUT 11.11.14



Microsoft  
Studios

343  
INDUSTRIES

\*Halo: Nightfall: 5 episode live-action series is streaming only, and will initially be available on a weekly basis, and then on demand. Xbox One or Windows 8.1 and broadband internet required; ISP fees apply. Halo 5: Guardians Beta: Game disc required. Limited-time beta starts December 27, 2014, and ends January 22, 2015. Must be 17+. Xbox One, broadband internet (ISP fees apply) and Xbox LIVE Gold membership (sold separately) required. Halo: Nightfall and Halo 5: Guardians Beta dates, content, and features subject to change. See [www.xbox.com/halo](http://www.xbox.com/halo)



## SNK Neo Geo X

Yes, it will never replace the original hardware, but when you consider the price difference it's hard to complain, particularly with the latest hardware updates. If you're not interested in playing classics such as *Metal Slug*, *Last Resort* and *King Of Monsters* on the handheld, you can link it up to your TV via HDMI for a more authentic experience.

**Price:** £99.99  
**From:** [www.funstock.co.uk](http://www.funstock.co.uk)



### Retro Gamer Annual

Christmas is just around the corner, so it's the perfect time to get yourself a massive slice of retro goodness. Our new **Retro Gamer** annual features some of the greatest content from the last 12 issues. It's filled with a large number of exclusive interviews, covers all number of classic games, from *Rampage* to *Resident Evil*, and costs less than a tenner.

**Price:** £9.99  
**From:** [www.imagineshop.co.uk](http://www.imagineshop.co.uk)

### Tetris Tetrimino Light

We've seen a whole lot of *Tetris* merchandise over the years, but this stylish light is arguably one of the most impressive. Using the blue Tetrimino as a base, you can then add additional classic shapes to create a unique light display. Rumours that part of your lamp disappears once a Tetris is created are greatly exaggerated.



**Price:** £29.99  
**From:** [www.amazon.co.uk](http://www.amazon.co.uk)

### Retro Gamer Coasters

Avoid annoying drink rings on your furniture and get a blast of nostalgia at the same time with our awesome coasters. Available in packs of four, these tough durable coasters feature some of the best **Retro Gamer** covers we've ever produced, making them perfect for your loved ones.

**Price:** £4.99 **From:** [www.imagineshop.co.uk](http://www.imagineshop.co.uk)



### Atari Bag

Despite its spectacular fall from grace, Atari remains one of the most iconic game brands of all time. You can now show your love for the Seventies developer by carrying around this impressive messenger bag. It's not only extremely well made, and pleasing to the touch, but also lets you easily store an Atari 2600 and several games. Perfect for visiting your mates.



**Price:** £29.99 **From:** [www.funstock.co.uk](http://www.funstock.co.uk)

## Sega Mega Drive: The Collected Works

Created with full support from Sega, *The Collected Works* is the perfect coffee table book. In addition to delving into the Mega Drive's creation and Sega's battle against Nintendo, the 352-page book also includes some rarely interviewed Sega employees, including Koji Tsuchida, Naofumi Hataya and Kotaro Hayashida.

This exclusive access also extends to the huge selection of incredible artwork that ranges from storyboards to blueprints of the original console, along with delicious rarely seen prototype images of failed projects like the Sega VR headset.

While it's somewhat disappointing that key games such as *Castle Of Illusion*, *Columns* and *Super Hang-On* are given little to no mention, there's no denying that this is an essential purchase for any Mega Drive fan.

**Price:** £35 **From:** [www.readonlymemory.vg](http://www.readonlymemory.vg)



PICK OF THE MONTH

## RETRO RADAR: COLLECTORS CORNER

**THE LEGEND OF ZELDA: A LINK TO THE PAST**  
 "It's actually a selection of items relating to my favourite ever game. In my eyes it's the perfect game and plays as good today as it did when originally released."  
**PAID: £100+**

**TEENAGE MUTANT NINJA TURTLES ARCADE BOARD**  
 "Our annual family holiday meant hours in the arcade and this was the one I had fondest memories of. This original arcade board is one of my favourite ever purchases."  
**PAID: £50**

**JEWEL IN THE CROWN**  
**THAT PIECE YOU CAN'T BE WITHOUT**  
**THE SMURFS TRAVEL THE WORLD - SEGA MASTER SYSTEM**  
 "This was quite a recent addition but one I never thought I'd get. Master System collectors will know that going for a full set means eventually having to part with some serious money... I know there are games out there that cost much more than this, but I'm delighted to finally have this one in my possession and the true Master System full set."

**THE LEGEND OF ZELDA: A LINK TO THE PAST SIGNED BY SHIGERU MIYAMOTO**  
 "I bought it off eBay about ten years ago so didn't get to meet Miyamoto like Leigh [see Collectors Corner RG134], but it's still a nice item to have."  
**PAID: £50**

**PERFECT DARK**  
 "When growing up, we played the N64 most due to its impressive multiplayer games and with this game, epic battles were easy to create. It's up there with the most important FPS on any console."  
**PAID: £50**

**MARIO KART WEDDING CAKE**  
 "Okay it's not a game and it's certainly not sitting in my games room, having been eaten four years ago! I scribbled down a design to give to the local bakery and bought some small toys to put on it."  
**PAID: £60**



**BIO**  
**NAME:** Stephen Bowler  
**ESTIMATED VALUE:** £25,000  
**MOST EVER SPENT:** £325  
**FAVOURITE CONSOLE:** Nintendo 64  
**FAVOURITE GAME:** The Legend Of Zelda: A Link To The Past

## Collectors corner

Readers take us through the retro keyhole

Last month's profile gave us possibly the most well-known videogame collection in the world. This month we have almost the complete opposite. "This is the first time I've openly talked about and shown off my collection to anyone other than to close friends and family," admits Stephen, who has been collecting 'properly' now since 2001. Living up to his RetroCollect forum name of theconsolecollector, Stephen estimates he owns 4,500 games, 150 consoles and over 100 miscellaneous items, and like many collectors he's been bitten by the complete set bug. "The N64 is my favourite console and I steadily built up a large collection," he explains, "until one day I stumbled across a full game list online and decided to give it a go." He now owns a complete worldwide set of

games for the console - although, unlike some, he's happy to have cart-only games in his collection given the price difference between these and boxed games. With a collection of this size, storage is obviously an issue. As a married man, what does Stephen's other half think of his hobby? "I'd been collecting a few years before we met, so she was well aware what she was getting into!" he laughs. "Now we just have a normal-sized semi-detached house so I have to ensure the space is used well." And while his recent £325 purchase of the rare Master System game *Les Schtroumpfs Autour Du Monde (The Smurfs Travel The World)* may have raised an eyebrow, retro collecting and marriage have so far co-habited well in the Bowler household.

In addition to games, Stephen also loves gaming-related merchandise. "Most of it is Nintendo-related, and looks great in my room," he says. And perhaps the most memorable piece of 'merchandise' for him is the *Mario Kart* wedding cake that sat alongside the more traditional one on his big day. "Have a guess which one had the most photos taken of it!" laughs Stephen. But, like Frank Sinatra, Stephen's had a few regrets over his time collecting. "Selling my SNES and Saturn collection when I wanted to upgrade my PC was a big one," he grimaces. "And although I bought back everything eventually, one thing I'll never get back was the Saturn I won on the TV show *Live And Kicking* in 1997. I've vowed never to sell my collection again!"







# Mike Diskett

The former Bullfrog coder chats about his new game *Satellite Reign*

## How did you come to the decision to do a spiritual successor to *Syndicate Wars*?

I had been watching the success of Kickstarter and had been considering one day many years from now using it to fund a remake of *Syndicate Wars*, without really knowing if it would garner any interest. About this time EA released the first-person shooter version of *Syndicate* which resulted in a lot of negativity from old-school *Syndicate* fans, and the sheer number of posts from old *Syndicate* fans gave me the confidence to think a Kickstarter might work. Some time later my employer at the time announced they were closing the game studio, giving us all six months' notice. This allowed us to get together our small team and plan out exactly what we would do next. I suggested we Kickstart a *Syndicate Wars* spiritual successor and the idea was leaped on by the team, all of which are old fans of the original games.

## What are the new twists that old fans of *Syndicate Wars* can expect to see in *Satellite Reign*?

There's a ton of differences; a big one is that agents are class based with specific skills and abilities for use throughout the game. Use of cover/stealth is a big feature of *Satellite*

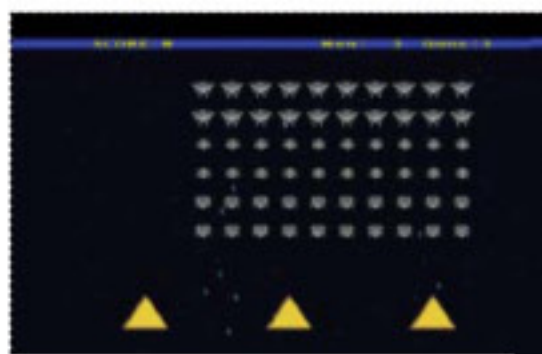

[Amiga] We did Google it - Mr Wobbly Legs Versus The Invaders From Space is a very real game.

*Reign* with constantly monitoring CCTV cameras, as well as hacking to unlock doors and deactivate cameras (among other things).

## What's been the hardest part of making *Satellite Reign* so far?

It's probably keeping our ambitions in check - we have a limited amount of funds to see us through and a relatively small team, but a ton of ideas, wish-list items and backer requests. I'm especially guilty of wanting to put in wish-list features ahead of even core functionality, like when I spent a weekend sneaking zip wires into the game!

**“Agents are class based with specific skills and abilities for use throughout the game”**

Mike reveals one of the many differences in *Satellite Reign*



[PC] You'll want to avoid searchlights in order to make progress in *Satellite Reign*.



[Xbox 360] After Mucky Foot, Mike spent a spell at Rockstar North as a programmer on *Grand Theft Auto IV*.

## How has game development changed since your career began?

When I first started I was a 68000 Assembly head, writing hardcore sprite/polygon routines direct to the metal on the Atari ST and Amiga, but even by the time I joined Bullfrog programming had become higher level with everyone working in C. Now I'm working in C#, a super-high-level language that allows me to be super-productive, using Unity middleware, which means I haven't had to spend six or more months creating a map editor and render engine.

The AAA games industry is totally different to 20 years ago, with teams

of hundreds - when I was at Rockstar North working on *Grand Theft Auto IV* we had a team of 200 developers compared to just a handful at Bullfrog. Indie development is actually very similar to the early days of game development, though, unconstrained by publisher funding and large team inertia - small indie teams can be ultra-creative, which reminds me of the creativity that existed in the Eighties and Nineties where every idea was new.

## How do you feel Kickstarter has changed things for developers?

Kickstarter is a fantastic way to fund the development of titles that otherwise wouldn't have seen the light of day, but it's not a magic bullet. Successfully completing a Kickstarter is a ton of work that requires a lot of planning, and in some ways is similar to launching a game - you live or die by the number of eyes you get on the Kickstarter and the percentage of views to pledges. I don't think Kickstarter has hugely changed the game development scene because the total percentage of games that are funded by Kickstarter is probably a fraction of one per cent, and it's very difficult to get traction there with original game ideas. Having said that, though, it's brilliant that games like *Mega Man*, *Elite*, *Wasteland* and *Wing Commander* are all being revisited.

## Would you like to revisit any of your other old games in the future?

The guys have suggested I remake *Mr Wobbly Legs Versus The Invaders From Space* (Google it, it really does exist) as a mini-game inside *Satellite Reign*. Other than that, there's *Urban Chaos* and *Startopia* as properties I own from Mucky Foot, but I'd love to keep expanding on *Satellite Reign* for a while yet before we move onto something else. Mind you, I have jokingly suggested we take on *The Sims* and set it in a bleak cyberpunk futuristic city... \*



[PC] It's good to see that you're still able to cause massive chaos in the city.

# THE STORIES, STRATEGIES, HEROES & MACHINES

www.historyanswers.co.uk



# HISTORY of WAR

ON SALE NOW

> Hitler's Waffen SS > Special Forces > Teutonic Knights > HMS Victory



## BUY YOUR ISSUE TODAY

Print edition available at [www.imagineshop.co.uk](http://www.imagineshop.co.uk)

Digital edition available at [www.greatdigitalmags.com](http://www.greatdigitalmags.com)

Available on the following platforms



facebook.com/HistoryofWarMag twitter.com/@HistoryofWarMag

# BACK TO THE NINETIES

► [Arcade] Judge Dredd Arcade should've been something special given the source material. It wasn't. 20 years in the Iso-Cubes, Namco...



► [Nintendo 64] The third instalment of ClayFighter feels tired despite some weird and wonderful character designs.

## THE LATEST NEWS FROM NOVEMBER 1997

**NOVEMBER 1997** – Sega dreams of Dural, Bandicoot 2 crashes in, not so Croft original for Tomb Raider 2, Diddy races in, ClayFighter 63½ gets a frosty reception while Dredd hits the arcades. Richard Burton takes a trip to Resyk...

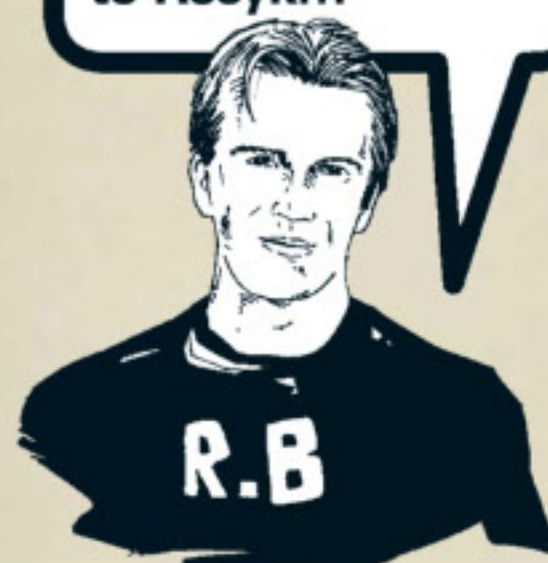

**S**ega was developing a new console codenamed Project Dural. It would be a powerful beast with a GD-ROM drive rather than a cartridge slot. The GD-ROM, or Gigabyte Disc Read Only Memory, was a format developed for Dural as a piracy deterrent. A GD disc also had approximately double the capacity of a CD.

Project Dural was still in the early stages of planning and development but would see its (almost) worldwide release a mere two years later, as the Sega Dreamcast. Japan strangely managed to get the Dreamcast a full year earlier than everyone else.

PlayStation gamers were to be treated to a trio of early Christmas gifts. First up was the sequel to the playable platform game *Crash Bandicoot*. The original developer, Naughty Dog, was behind the sequel, so fears of a shabby cash-in were unfounded.

*Crash Bandicoot 2: Cortex Strikes Back* hit the shops early November and immediately impressed, with many lauding it as having given us a significant improvement over the original. It also sold incredibly well.

The evil Dr Cortex pulled the storyline strings with tales of saving the world by obtaining crystals which Crash was duped into locating. What Cortex

failed to mention was that the crystals would form part of his super Cortex Vortex laser which would brainwash the inhabitants of Earth into serving him.

*Crash Bandicoot 2* featured improved graphics and sound, with both executed extremely well. The gameplay was commented on in the gaming press as rather lacking originality, but when it's as honed as stylishly as this, that is forgivable. *Crash Bandicoot 2* was platform gaming at its uncomplicated, unassuming best.

For PC and PlayStation gamers there was Core Design's third-person action-adventure game *Tomb Raider II*, which continued the adventures of

### NOVEMBER WORLD NEWS

4 November saw the premiere of the science-fiction action movie *Starship Troopers* starring Casper Van Dien, Denise Richards and Michael Ironside. Join the military, fight a planet of oversized insects and become a citizen of Earth. Would you like to know more?

There was more sci-fi action on 6 November with the fourth *Alien* movie, *Alien: Resurrection*. It starred *Alien* stalwart Sigourney Weaver as Ripley, back as an alien/human hybrid

clone after being killed off in the third movie and, again, taking up the fight against the Xenomorphs.

21 November saw videogame-based movie madness when *Mortal Kombat: Annihilation* hit cinema screens. An invasion is coming from Outworld, another dimension ruled by evil leader Shao Kahn. A group of martial arts warriors must do their best to stop him merging Outworld and the Earth realms together and they have just six days to stop him.

*Mortal Kombat: Annihilation* was guff of the highest order.

22 November marked the death of Michael Hutchence, lead singer of Australian rock band INXS. The 37-year-old was found dead in a hotel room in Sydney. He had hanged himself with his belt from the door. The coroner reported that depression brought on by the ongoing custody battle between Hutchence, Paula Yates and Bob Geldof had been a contributing factor in his death.

## CHARTS

### NOVEMBER 1997

#### SEGA SATURN

- 1 Resident Evil (Capcom)
- 2 WipEout 2097 (Psygnosis)
- 3 King Of Fighters '95 (SNK)
- 4 Jona Lomu Rugby (Codemasters)
- 5 Alien Trilogy (Acclaim)

#### PC

- 1 Little Big Adventure 2 (Electronic Arts)
- 2 Dungeon Keeper (Electronic Arts)
- 3 Championship Manager: Double Pack (Eidos)
- 4 Command And Conquer: Red Alert – Counterstrike (Virgin Games)
- 5 Atomic Bomberman (Interplay)

#### PLAYSTATION

- 1 V-Rally (Ocean)
- 2 International Soccer Superstar Pro (Konami)
- 3 Alien Trilogy: Platinum (Acclaim)
- 4 Worms: Platinum (Ocean)
- 5 Tomb Raider (Eidos)

#### MUSIC

- 1 Barbie Girl (Aqua)
- 2 Torn (Natalie Imbruglia)
- 3 Perfect Day (Various Artists)
- 4 Candle In The Wind (Elton John)
- 5 Tell Him (Barbara Streisand & Celine Dion)

Lara Croft. Gameplay was very similar to the original: complete the levels by solving puzzles, defeating enemies and collecting objects, the overall aim being to recover the Dagger Of Xian, which transforms its owner into a dragon. Lara was also freshly toggled and tooled up with a ponytail, new clothing and an arsenal of new weaponry. *Tomb Raider II* proved a huge hit, eventually shifting an impressive 8 million copies worldwide during its retail life.

Rare Ltd had been developing a *Mario Kart*-style game for the Nintendo 64. It was now ready. *Diddy Kong Racing* was modelled on *Mario Kart* and although criticised in the press for following this line, Rare would've been daft to deviate too far from a tried and tested, winning formula. However, there were additional features such as the ability to change your transport from kart to plane or hovercraft to suit particular stages. As it turned out, *Diddy Kong Racing* was a splendid piece of gaming.

November saw the return of a classic old beat-'em-up for the Nintendo 64 in the form of Interplay's *ClayFighter 63½*. It once again employed the stop-motion type of animation, with its

► [Nintendo 64] Rare Ltd on top form again as Diddy Kong does a *Mario Kart* with a top-drawer racing game.



► [PlayStation] Lara Croft and her beautifully honed pixelated assets return and are on splendid form.

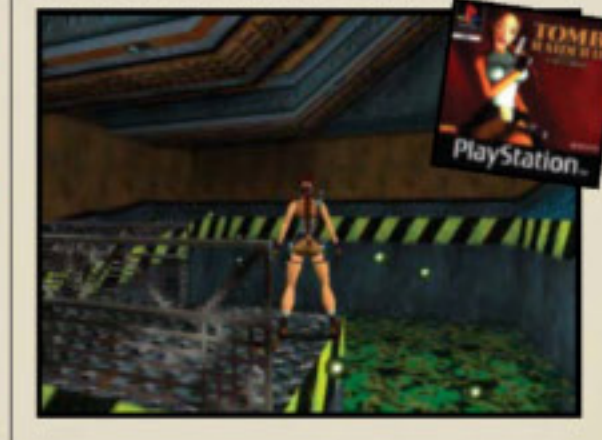

pre-rendered sprites giving *ClayFighter* its unique graphical style.

It also continued with the roster of bonkers characters that had been a theme of previous games. There were 12 characters in all with fan favourite Bad Mr Frosty, the fighting snowman, reappearing. Other characters included a cyborg rabbit and a guest appearance by Earthworm Jim. Groovy.

As a fighting game it was merely okay, but the weirdness and humour of the characters won fans over, nullifying the effect of more important factors such as ropey gameplay.

A later version of the game entitled *ClayFighter: Sculptor's Cut*, was released for the rental market



► [PlayStation] Crash Bandicoot and Dr Cortex go at it once again in a terrific platform game sequel.

### THIS MONTH IN... OFFICIAL SEGA SATURN MAGAZINE

Lobotomy Software, the firm behind the Saturn versions of *Duke Nukem 3D* and *Quake*, featured in an interview. When pushed on which was best, *Duke Nukem* or *Quake*, it sat firmly on the fence by saying they're both great but also very different, making it hard to compare. Cop-out!



### NINTENDO POWER

Fresh from a tour of Konami's studio in Japan, *Nintendo Power* had in-depth previews on forthcoming Konami titles including *Dracula 3D* (later renamed *Castlevania 64*), *Hybrid Heaven*, *G.A.S.P. Fighters' NEXTeam* and *Nagano Winter Olympics '98*, all of which were being developed for the Nintendo 64.

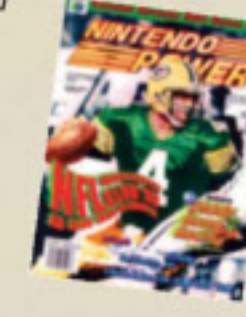

### ELECTRONIC GAMING MONTHLY

It was congratulations to US publication *EGM* on reaching the landmark 100th issue this month. Published by Ziff Davis, it ran until January 2009, ending on issue 236. *EGM* Media later bought the title and it was relaunched in April 2010 under the stewardship of original founder Steve Harris.



exclusively for Blockbuster and became one of the rarer N64 games. Be prepared to spend £150 plus on bagging a good loose cartridge example and several times that for a complete mint boxed edition.

In arcade land there were three new releases for you to pump your coin of the realm into. From Acclaim and Gremlin Interactive came *Judge Dredd Arcade*, based on the anti-hero and lawman of the future from the pages of *2000AD*. It originally started out as a completely different themed first-person shooter. After development shenanigans and two further name changes, the game morphed into *Judge Dredd Arcade* and was released. Sadly, it wasn't worth the wait. It was sluggish and monotonous and thanks to some truly awful FMV cut-scenes, funny for all the wrong reasons.

*Rushing Heroes* from Konami was something of a rarity inasmuch as it was a sports simulation that played rather well. In this American football game, you got to choose your strategic plays and attempt to beat the CPU player. Graphically it was very good, with large rendered sprites animated realistically on a 3D perspective field. Whether you played offence or defence, you got to determine your play each turn from a selection on screen and, if attacking, your quarterback could select who to throw to.

The last new coin-op release this month was *Rapid River* from Namco. As the name suggests, it was a white-water rafting simulator with you controlling your raft by means of a paddle controller situated on the big orange raft cabinet. Although it had a novelty game feel, *Rapid River* was good fun. Controlling your raft down a frothing river, avoiding protruding rocks, escaping from whirlpools and being chased over waterfalls by a T-Rex were just some of the joys to be had. Paddling furiously as if you were being trailed by a torpedo while your body converted itself into a seething ball of lactic acid and your shoulders were set to explode in your face was enjoyable and painful in equal measure. \*



PATRIOT

**WIN!**  
RETRO GAMER  
COASTERS

Upload your classic profiles for your chance to win [www.retrogamer.net](http://www.retrogamer.net) or you can buy your own coasters for £4.99 from [www.imagineshop.co.uk](http://www.imagineshop.co.uk)

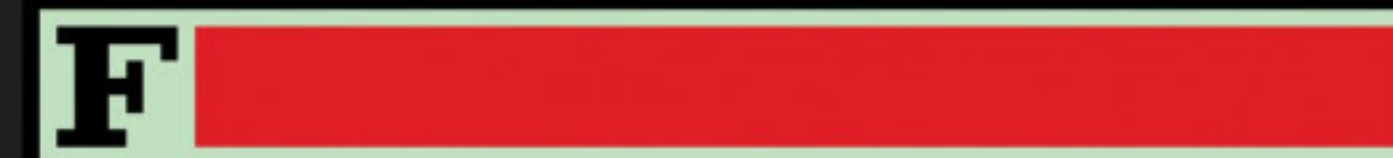

11:30

Vous etes  
Programmeur?



## Zombi

"IT'S NOT A SANCTUARY, IT'S A PRISON!"

#82

UBISOFT • ATARI ST • 1990

Apart from being the first game released by the fledgling French publisher Ubisoft, *Zombi* is notable for being from a time where unofficial movie 'tie-ins' weren't considered important enough to take legal action over. *Zombi* is the name by which George Romero's 1978 cinematic gore-fest *Dawn of the Dead* is known in Europe, and the game takes the movie's premise and changes very little.

The game begins at the point in the movie where the four main characters arrive by helicopter at a shopping mall. If it isn't obvious from the title, the world is under siege from a zombie plague, and our heroes are seeking refuge. Upon arrival, their goal is to secure the shopping mall and hole up until the dead decide to lie down again.

The game is a first-person *Dungeon Master*-style trek through the mall, with everything controlled by the mouse. Characters may be switched at will, but making sure the inactive ones are in a safe place before choosing another would be a smart move. There's little difference between the four protagonists, other than Alexandre is the only one capable of piloting the helicopter, and the token female Sylvie can't use a gun for unexplained reasons (pacifism?).

*Zombi* is fairly straightforward and not terribly deep; fans of the movie will progress pretty quickly and it can be completed in about an hour once you know what to do. However, this kind of horror scenario wasn't very common back in 1990 and it was pretty entertaining at the time.

Based on some strong reviews for the Spectrum version, *Zombi* was the second game I bought for my shiny new Atari ST. The manual came with a cartoon-strip prologue that looked like it was sketched on a napkin during lunch; not something you'd see too often these days. ★

DAVE SKILLIN

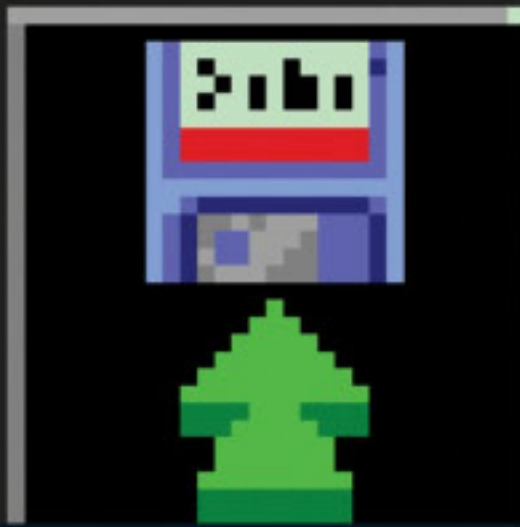



30 YEARS OF BEING ELITE



### When Elite launched in 1984, its 3D graphics and sandbox gameplay were revolutionary. Now, 30 years on and with a fourth game due for release, co-creator David Braben talks to David Crookes about the impact of the series

There can be very few people who have not heard of the masterpiece of programming that is *Elite*. Some have compared it to *Citizen Kane*, the Orson Welles film classic of 1941, but while we perhaps wouldn't go that far, there's no denying the sheer impact of Ian Bell and David Braben's game.

With a feeling of isolation that only a bleak universe can bring yet punctuated by the possibility of action, *Elite* could be both lonely and arresting. Flights would be suddenly interrupted by a space war or an opportunity to steal and trade. Different worlds would lead to different possibilities. Players could take basic machinery, food and raw materials from an agricultural world and sell it to an industrial one. They could operate on the black market, dealing in slaves, narcotics and firearms.

In 1984, this kind of sophistication in a game was incredibly advanced and yet there was an early chance that *Elite* would never even see the light of day. Infamously, Thorn EMI turned it down, put off by realistic physics and out-of-this-world gameplay that dispensed with multiple lives and the usual game mechanics of the day. But when Acornsoft got its hands on it, the firm knew it had something special.

From the moment it was shown off at a press launch in Thorpe Park – one of the first games to receive this kind of treatment – *Elite* caught the imagination of both the gaming and non-gaming press and went on to spawn three sequels. "That event created so much evangelism for the game and it was clear that people wanted it," David Braben tells us.

# ELITE

On 20 September 1984, a true game changer was launched. Its name was Elite and it would go on to influence countless videogames for years to come. Created by university undergraduates Ian Bell and David Braben, it presented players with a vast, open 3D world. Gamers would set off from the planet Lave in a Cobra Mk III spacecraft with little more than 100 credits to their name. On their journey through the galaxy, they would become a space pirate, making their virtual living through trade, in a game that dispensed with multiple lives and time limits and simply aimed to absorb the player in the experience.

Elite has been a very influential game, but what was it that influenced you? A lot of different factors came together at the same time. I read science-fiction books avidly, but the late Seventies was also the period when sci-fi first started to appear at the cinema, with Star Wars being the most obvious one. It had some of the atmosphere that I'd got from the books whereas TV – the likes of Star Trek – didn't really cut it. TV programmes were a bit too removed somehow and the same could be said for games at the time. I was more negatively influenced.

Which games caught your imagination at the time? When we were writing Elite, we played games like Defender, Galaxian and Pac-Man. But I also liked Philosopher's Quest. What I liked most was the way you saved your position and the way the pace of the game was a bit more measured. Most of the other games that I played were a frantic few minutes and then a frustrating death.

Did you want to produce something different to those? Games like Space Invaders or Defender, where you would get an extra smart bomb at 5,000 and an extra life at 10,000, felt so regimented. I thought "what if you got two smart bombs and no extra life?" I would want to choose. I also thought games were structured too much around the coin drop and so many home computer games were just direct derivatives of arcade games. I wanted to have much more considered games where you could



The sheer wealth of content found in Elite puts many current special editions to shame.



[BBC Micro] You can switch between different viewpoints, further adding to Elite's immersion.



[BBC Micro] So tell us, where do you want to go today? The possibilities are endless.

stop and save your position and come back the following evening. How was the development work split with co-creator Ian Bell? We tried to split the tasks 50/50, but the way it worked in practice was we both worked on each other's code all the time. An awful lot of time was spent trying to do what we call byte-savings, which was a surprisingly rewarding way of trawling through, thinking "wow, I can rewrite those ten instructions into nine instructions and save two bytes" or "I could look at this, I can change that, I can do this here, and then we can save two bytes here as well".

Elite stripped away many familiar aspects of gaming such as time limits and lives. Why did you believe those mechanics were unnecessary for Elite?

Arguably Elite does have lives: it has one life. But it was a slightly bizarre feeling of "why three? Why not infinite?". I love games that mix it

up a bit. Before Elite, the experience of publishers was very much about making games that were copies of arcade games and if you look at the catalogue of games immediately prior to Elite, there was very little experimentation. What I think we did was unlock publishers' willingness to experiment. Publishers had rejected Elite as a wonderful graphics demo and then came to think "we want some of that". So it's not that we inspired the developers – I think there were a lot of different experimental games that people were probably already making – but it was more



[BBC Micro] Detailed descriptions of each planet gives you the impression of visiting exciting new worlds.

## WHY I LOVE ELITE

Elite proves that the impossible is possible in 32K of RAM. And it's fun too. Elite was also one of the first games that generated stories based on escapades you had in the game.

GRAEME DEVINE,  
DEVELOPER OF  
THE 7TH QUEST



## GRAND THEFT AUTO III

Considered to be Elite's natural successor, the explorative, sandbox, mission-based play of Grand Theft Auto's first 3D foray was testament to Sam and Dan Houser's immense appreciation of Ian and David's game.

## WING COMMANDER: PRIVATEER

More linear than Elite but still with the free roaming ability, Privateer was a Wing Commander game, albeit one that involved cargo shipping, bounty collecting, combat and craft enhancements.

## X: BEYOND THE FRONTIER

Egosoft's debut game in the X-universe felt like a simpler version of Elite, but there was an identical sense of adventure with base-to-base, travel, lots of trading and ship upgrades.

## EVE ONLINE

Eve's senior producer Nathan Richardson has never denied the influence Elite has had on his game and with a huge galaxy to explore, interplanetary trade, docking and shooting, the similarities are stark.

## EIGHT GAMES ELITE INFLUENCED

The impact of Ian Bell and David Braben's game can be seen in a great many other franchises...

### OOLITE

The name of this first-person, open-ended space trader stands for 'Object Oriented Elite'. It began as a fan effort which has grown in popularity and shows Elite's influence on gamers as well as developers.

### FREELANCER

As mercenary lawless adventurer Edison Trent foraged his way through the darkness of space, relationships with friendly or hostile factions played a big part, whether gamers assumed the role of pirate, trader or bounty hunter.

### SPACE ROGUE

Space Rogue took Elite and added filled-in 3D graphics, realistic physics and RPG elements. Its successful blend was enough for Zzap64 to call it the greatest ever space game.

### DEEP SPACE

Although marred by annoying controls, Deep Space pitted players in a STRIX fighter and plunged them into deep space, letting them earn credits for better weapons and energy boosts.

that we inspired the publishers to go with the developers' ideas. For at least two to three years we saw a lot of new genres come up that hadn't and probably wouldn't have been considered by a publisher before that.

### Why did you decide to include trading in the gameplay?

We brainstormed a few different ways to make you care about your ship and we were both afraid that trading would be a bit boring: "What do you mean? You're buying at a

certain price and selling a bit higher? Big deal, that doesn't sound exciting; that doesn't sound like a competitor to Space Invaders or Defender". But we tried it out and thought, actually, it is quite compelling. You care so much more if you've got a cargo of gold that you're trying to get through if you're actually making a journey, rather than just trying to survive two-and-a-half minutes.

### This also allowed players to assume a role, didn't it?

Once you had the survival, it felt the score was money essentially and we contextualised all of that in terms



[BBC Micro] Discovering exciting new locations has always been a massive draw of the original Elite.

You care so much more if you've got a cargo of gold you're trying to get through, rather than just trying to survive

David Braben emphasises the importance of Elite's trading aspect

of bounties so as soon as you had the idea of carrying cargo, all the other roles felt quite natural. "I'm attacking someone because I want their cargo" – so you're clearly a pirate. And having a bounty on your head also seemed logical. Then you could be a bounty-hunter without actually breaking the law. So the idea of law was added. It came together quite quickly.

### Was there any frustration over the restrictions that the BBC Micro placed upon you?

It wasn't as bad as that. I had an Acorn Atom and I wanted to write this thing where you flew through an expanding sphere of star field, but I was horrified by how slowly it drew in BASIC: you'd see the

stars appear, undraw them and redraw them and think "oh, you've lost any persistence of vision". You had no feeling of 3D at all. I sat down to learn machine code and I thought there's got to be a game here because it's so lovely. It was an empty world, but you had such a sensation of motion and of 3D that it felt compelling and that's why I tried to work out how to draw 3D shapes. So with Elite, it was a bit back to front; it was very much driven by the technology, as in that came first and then it was "all right, it needs a spaceship, that would be fun to fly around and fight". And fighting in 3D actually felt great. It felt different.

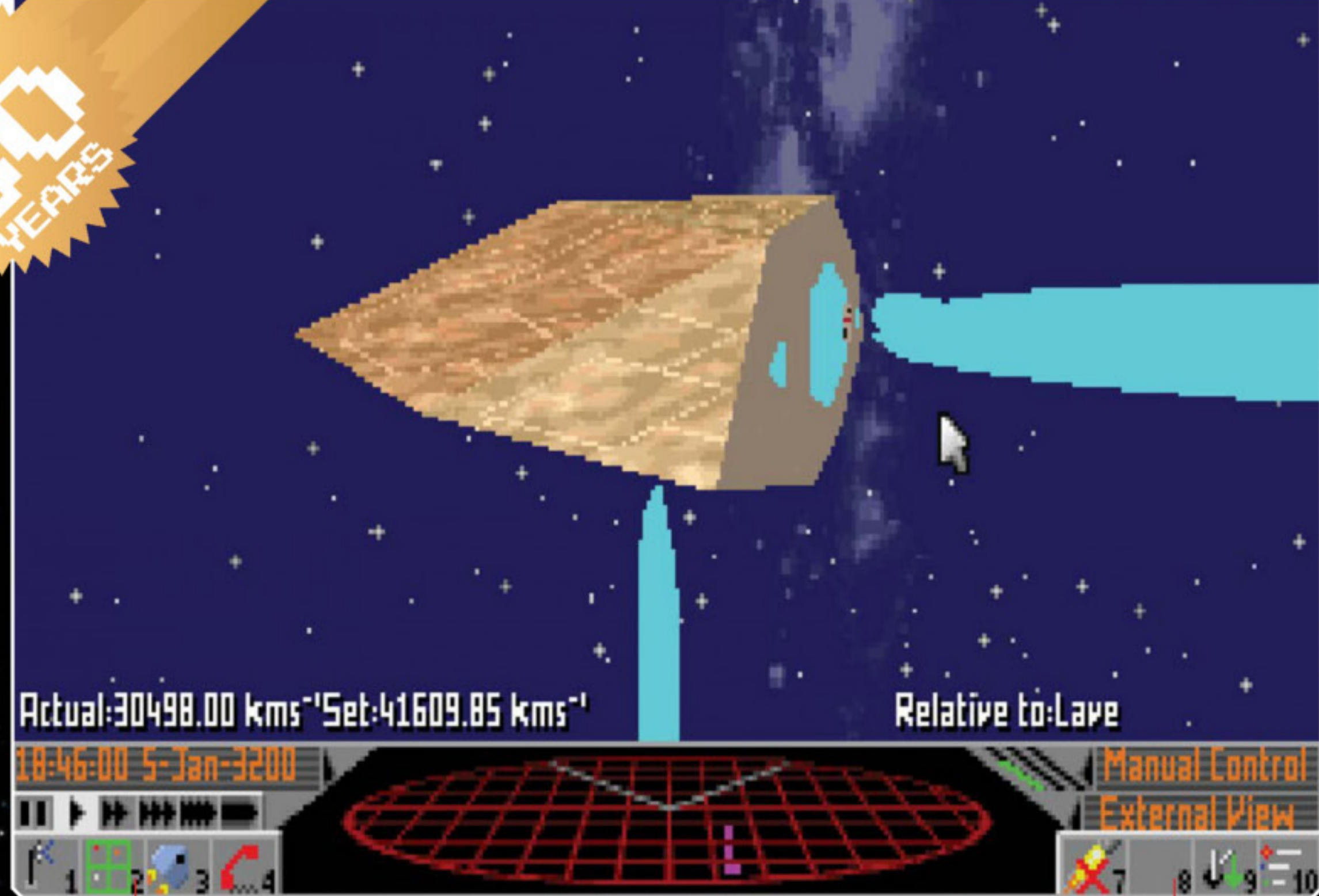

Actual: 30498.00 kms 'Set: 41609.85 kms'  
 18:46:00 5-Jan-3200  
 Manual Control  
 External View

# FRONTIER

If *Elite* was in the right place at the right time, the same could not really be said of *Frontier*. Work began on the game in 1988 but it would not be released until 1993. By that time, gaming had moved on rapidly. And yet, as with the debut game, *Frontier* showed great ambition. Not only were the 3D graphics in colour, it was the first game to feature procedurally generated star systems. It also had accurate physics. Best of all, with no end-game, it could go on forever. *Destiny* was truly in the hands of players, with gamers free to be whatever they wanted, from a miner to a mercenary to a trader or pirate.

**Was it very difficult to produce *Frontier* given the preconceptions of the first game?**  
 I think so, especially when people's expectations had got very high. It's always a difficult balance.

***Frontier* provided more of the same in a sense. What would you say were the important things it brought to the table?**  
 For me, just the sheer scale of the galaxy and contextualising something real within the game environment was very exciting. And I think in terms of the richness of the game, *Frontier* did a lot more in terms of the way the missions worked; in terms of actually having some politics in the galaxy; the idea that you could be a bad guy in one place and a good guy in the other place at the same time. I thought that worked quite well in a game-type environment.

**The game also saw a number of firsts. What stood out for you, looking back?**  
 I think it was the first game to have curved surfaces and real-sized

planets. It also pushed a sheer number of polygons. Certainly in 1988, when I first wrote it, the game was way ahead of its time.

**You wrote *Frontier* alone, didn't you? Was it difficult?**  
 Yes, the development work was mostly me and it took nearly five years, which was a little bit soul-destroying, especially seeing how quickly and how much the games industry changed from when I started to when I finished. Chris Sawyer, over the last period of that, did the conversions to PC.

**So was it annoying when the game was criticised for its physics by people who believed it made it a little bit more boring?**  
 I think *Frontier* was less well balanced but what was particularly frustrating for me was, just before the game was being released in that summer, Konami decided to stop making PC games and it sold its games business to a new company called GameTek. It had no real testing facilities and I was very unhappy at



the transition. I think the game was a lot worse for it.

**In what way?**  
 With the first *Elite* and with *Elite: Dangerous* we had good time to get it feeling just right, whereas *Frontier: Elite II* and, even worse, *First Encounters* after it, were rushed. I think that was a tragedy because I think I could have got the physics right but it does take a lot longer than you think. People think you're only setting a few numbers but there's a lot of trial and error in exchanging the way the code works, to get it to have that feel that feels really good.



Stable system with 25 major bodies.  
 Habit's system forms as both the birthplace of humanity and as the political capital of the Federation. It was important and prestigious system to live in, and a possible threat to the planet. Most rich humans will visit Earth and their base. All the major corporations have their headquarters on Mars, transferred in 2286, which is the main centre for administration.



• [DOS] Bulletin boards can offer all sorts of information, including buying and selling cargo.

**Why did you decide to include communication with other pilots and starport control?**

I liked the circular richness and symmetry of it. You could sign up to be an assassin, but you could also inadvertently sign up to be assassinated and get an assassin on your trail. It was often because you did something in the game where you crossed someone or you killed someone. The first message they would give you was, "I got a message to you from the name of the person in the previous mission, that will teach you to mess with them" or something so it was

quite clear what it was relating to. I liked the fact you were just one of many people going about their business.

**Some of the graphics could be a little jerky and at times it could make combat difficult. Did the problem surface as you were making the game?**

When I was developing the game I happened to know from Commodore they were planning high-spec machines, so I designed it to be capable of taking advantage of the higher-end machines and yet be reasonable on the lower-end ones. I think part of the problem was a lot of people tended to ramp the detail right up and then complain that it was going slowly. Maybe I should have made it automatically sense the speed of the machine but, as it happened, most of those machines weren't out by the time the game shipped. So even though I had one at home, it would have been a high-risk strategy to go "all right, what speed CPU is this? I'm going to tweak the game for it". I wasn't certain how the graphics were going to change.

***Frontier* had a greater emphasis on missions rather than trading. Were you moving away from that trading at this stage?**

Not really; the trading was very much the same, but what I wanted it to be was more of a range of things you could do. I had expected *Frontier: Elite II* to be played by taking on a juicy mission and then

## 30 YEARS OF BEING ELITE

### WHY I LOVE ELITE

*Elite* was, for me, the definitive space trading game of the 8-bit and 16-bit eras – it took many years for anyone to come up with anything close. Hopefully *Elite Dangerous* can be the one to steal the crown.

**ROBERT TROUGHTON, DEVELOPER OF DESTRUCTION DERBY AND WIPEOUT**

thinking "I'm going there so what's the right trade good to carry at the same time?". I think it made the game richer as a result. We could always have deleted the missions or ignored them and the trading would have had the same importance as the original *Elite*, but I think gamers' expectations had moved on and if *Frontier: Elite II* was similar to *Elite* people would have said it's very dull, there's not enough to do.

**Classical music accompanied docking and combat. Did this hark back to your love of sci-fi film?**

I always loved the juxtaposition of classic music and action. *Star Wars* did it, for example, but I think it was a real tribute to what Stanley Kubrick did in 2001: *A Space Odyssey* with *The Blue Danube* and docking. People forget the original *Elite* didn't have *The Blue Danube*; that was added later. If you contextualise the sort of music that was in games at the time of the release of *Frontier: Elite II*, it was still very plunky plunky – interesting but it didn't work very well with a space game.



### WHY I LOVE ELITE

When Andrew and I first saw *Elite* in 1984 we were enthralled. This was way beyond anything we thought technically possible. When we started playing, we were sucked into this amazing world of piloting spaceships, dogfights and trafficking narcotics between different solar systems whilst avoiding pirates and police patrols. Its scope was awesome and totally engrossing. It was in a league of its own.

**PHILIP OLIVER, DEVELOPER OF THE DIZZY SERIES**



**SIM CITY**  
 Will Wright's open-ended city-building game has no definitive ending. Wright wanted players to experiment and learn from mistakes, so you can just keep going, building that metropolis.



**THE SIMS**  
 In this open-ended 'life' game, your characters can get jobs, eat, sleep and make friends. But while there is no end to the possibilities ahead of you, there is no neat finish either.



**SPORE**  
 Dubbed a "truly endless universe of creative expression", *Spore* goes on and on, taking players from a tidepool phase of evolution through creature, tribal, city, civilisation and into space.

## THE ENDLESS LOOP

Other videogame classics with no definitive ending

**ROLLERCOASTER TYCOON**  
 Quite apart from the sequel's Mr Bones Wild Ride being never-ending, *Rollercoaster Tycoon* lets you continue building, producing the best theme parks you possibly can.



**CHAMPIONSHIP MANAGER**  
 Season after season rolls by and you move from club to club seeking league and cup glory with your team. *Football Manager* is the current favourite, offering the same open-endedness.



### TETRIS

As long as you can continue to stop the blocks from reaching the top, it'll never end. You may even get Tetris Syndrome (when the game starts to pattern your thoughts).



# FRONTIER: FIRST ENCOUNTERS

For the first time, Braben's latest game was a true team affair, but development was beset by problems. From a falling out between David Braben and Ian Bell to pressure from GameTek to release the game early, *First Encounters* was a bug-ridden disappointment for so many fans – and, it would seem, Braben himself – compounded by technical issues that were difficult to resolve. And yet the game's fractal landscapes looked stunning, the lack of loading screens made for a wonderful seamless experience and the alien-based missions were a joy.

*First Encounters* had a development team of ten. Was it a relief to have more hands on the pump? It was a relief but it also posed massive challenges because I hadn't really run a team before. I think one of the problems that was very apparent with *Elite* on the PC [conversion] that Chris Sawyer did, was that it didn't fit very well on the PC. The PC at that point was really a broad range of machines, using 286 and 386 Intel processors and one of the problems was the way they mapped their memory. The original game that Chris Sawyer

had written used various pages of memory, because the PC was designed to have 640K of memory in pages and that was a real pig to use if you wanted the game to get any bigger; to make the screen a higher resolution was very difficult. And... the problem is the data set [for *First Encounters*] was also so much bigger than the original *Elite*. Did the size cause you problems? With *First Encounters* we were going to have a much bigger footprint, so we had to re-implement the code and a much flatter memory model

to enable it to go much faster and enable us to support much higher resolutions and arbitrary resolutions. The game looked brilliant in the high resolutions, or what were high for the time, but we had to make a lot of changes. GameTek wanted to bring the release of the game forward and yet we had a lot of problems, the most fundamental being that the tools to develop [on] the PC hadn't settled down: you were writing it essentially as a 32-bit application and that was a real problem for

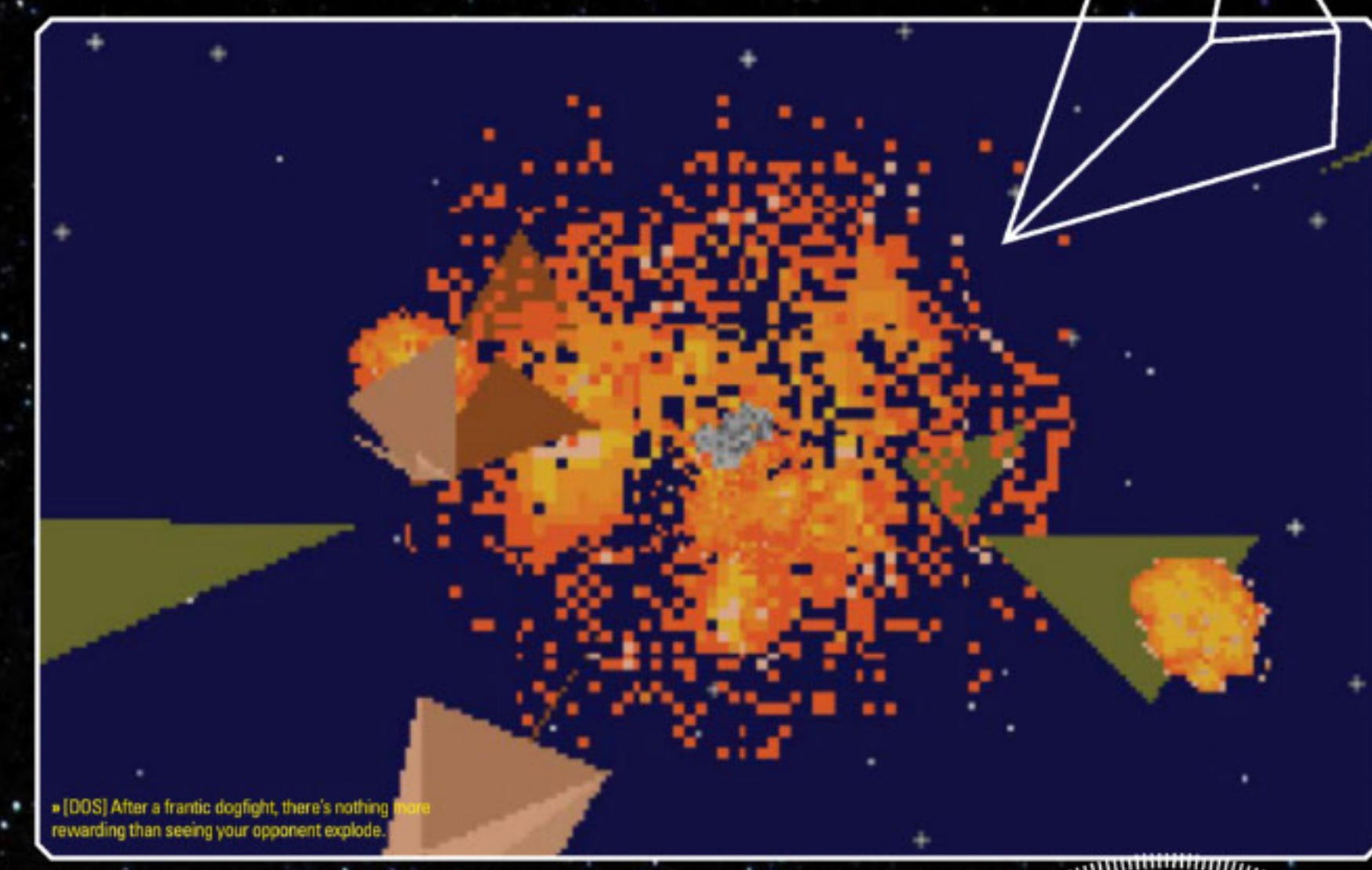

» [DOS] After a frantic dogfight, there's nothing more rewarding than seeing your opponent explode.

The game was also the biggest of the three games up to that point, wasn't it? Yes. The graphics were improved with shading and texture mapping but we had wanted to go further, which was the reason for rewriting the code, a different code base, so that we could be a lot more ambitious.

Was anything left out? We had a whole sequence of very interesting linked missions and I think some hackers have actually looked at some of the code and seen that there's a whole set of mission threads to do with the Thargoids that were closed off. I think that was a real shame. But that's what we had to do, because GameTek was absolutely insistent that the game shifted before the end of its financial year. I think bad things would have happened had it not, but that was so much the wrong thing to do and I learned so much from it.

Is this why the game was quite buggy then? Oh the game was horrendous. It wasn't ready. The first release actually had in capital letters across the front 'Beta Release: Not for Public Release' or words to that effect. It was pretty shocking.

So this was quite apart from anything that was happening between yourselves and Ian Bell? Yes, it was, although I think that sort of rolled into it at the time. I'd not worked with Ian for a long time, but he got a percentage off *Frontier* and not off the later sequels and it caused a problem. We fell out and it's a shame. It's always a shame when that sort of thing happens.

**WHY I LOVE ELITE**

With *Elite* I felt the awe of flying my own spaceship through a 3D universe... from moons to planets then enjoying the thrill of combat, all intermixed with the calming pleasure of shopping. The now-tense now-relaxing emotion sandwich of fighting and shopping remains the watchword in wisely designed player palate cleansing.

**MARTIN HOLLIS,**  
DEVELOPER OF GOLDENEYE

**WHY I LOVE ELITE**

*Elite* passed me by first time around because I was Sinclair rather than BBC. And, for some reason, I didn't play it when it was ported. I feel deeply ashamed.

**CHARLES CECIL,**  
CREATOR OF  
BROKEN SWORD



» [DOS] *Frontier* may have suffered from bugs, but its space combat is still massively enjoyable.



» [DOS] The sheer size of *Frontier: First Encounters* meant the team often struggled behind the scenes.



» [DOS] The amount of information is staggering. You can even discover a system's population.

development. It meant the game didn't get very much attention; sadly. But the game did have some firsts... That's right, and I think certainly from a technology point of view, the way some of the things we were doing with modelling the planets when you were a lot further ahead was something to be proud of. We had modelled how the atmospheres worked. And if you went to stars

like Vega, they were almost like Smarties: their equatorial radius was so much bigger than their polar radius because they're rotating so fast. We created a bit of interest in the geography. We also had detail within the in-game newspapers. You could subscribe to up to five different papers, each of which was telling different stories from a different perspective.

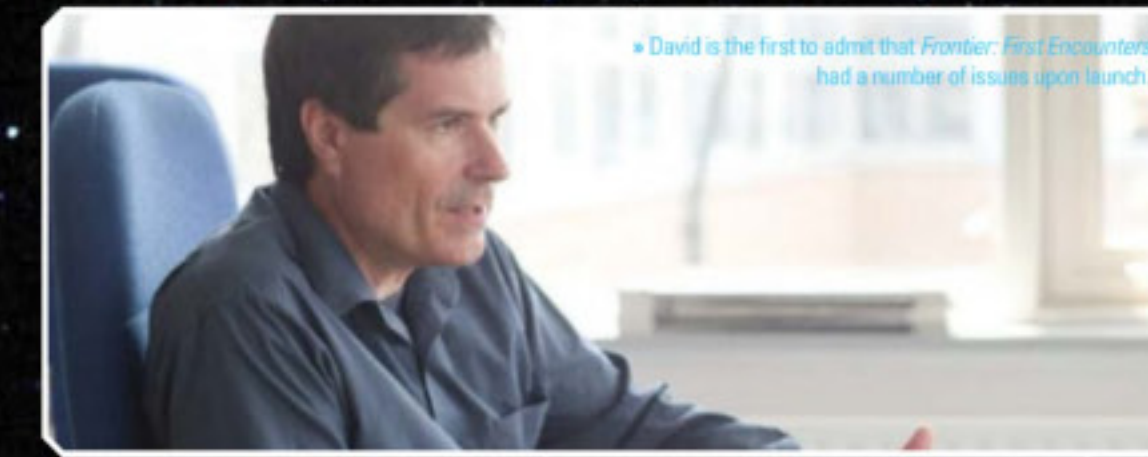

» David is the first to admit that *Frontier: First Encounters* had a number of issues upon launch.

## WE HAVE A PEST PROBLEM

*Frontier: First Encounter* wasn't the only big game with bug issues...

**FAIRLIGHT II: THE TRAIL OF DARKNESS**

■ The Spectrum isometric arcade-adventure had an horrendous bug. Gamers could only get to the final door, which refused to open without the use of a POKE. The bug had not been fixed since the publisher decided to release the game in a beta state, very much against the wishes of programmer Bo Jangeborg.

**THE LEGEND OF ZELDA: OCARINA OF TIME**

■ Nintendo dropped a few clangers in this 1998 N64 game. There are so many, entire websites are dedicated to listing them. One bug lets you defy gravity; another lets you lift the man in the archery gallery, enabling you to see how the artists neglected to draw him a pair of legs. It's even possible to bypass much of the game.

**BUBBLE BOBBLE REVOLUTION**

■ When this retro classic was given a fresh spin in 2005 on the Nintendo DS, the American version came with a terrible bug that omitted the boss at the end of level 30. It prevented players from progressing to level 31, rendering the final 70 (!) levels unplayable. Codemasters apologised and included *Rainbow Islands Revolution* in replacement copies as compensation.

**POKÉMON RED/BLUE**

■ A glitched Pokémon species dubbed MissingNo. (short for missing number) wreaked havoc in the original game. Catching it meant the game tried to access data that just didn't exist and this would allow the replication of the sixth item in the player's item bag. But it could also crash the game, lead to graphical glitches and corrupt the save file.

**JÉT SET WILLY**

■ The infamous Attic Bug involved the player entering a room called The Attic, whereupon the game would corrupt, removing enemies from The Chapel and making death traps of others. Programmer Matthew Smiths said the issue was to do with buffer overflow, but Software Projects at the time insisted the bugs were intentional. For a spell anyway; it later issued a patch.

**SPACE INVADERS**

■ When Tomohiro Nishikado created *Space Invaders*, the idea was that all of the aliens would stay at the same speed. But he found that the more enemies that were killed, the faster the remaining aliens would move. Rather than attempt to fix this bug – caused by freeing up the processor – Nishikado left it in and it turned into a popular feature.



» [DOS] The graphics were extremely impressive for the time, ensuring you always wanted to explore.



# ELITE DANGEROUS

Exactly 30 years on, the time is right for a return and what a triumph it is proving to be. Elite's status as one of gaming's most influential titles helped to persuade 25,681 Kickstarter backers to pledge a whopping £1,578,316 to fund the third sequel, Elite: Dangerous. It may still be in beta but it's a belter, having started with a single star system and with 400 billion set firmly in its sights. There's asteroid mining, the ability to own multiple ships and full-use of online capabilities. There have even been speed docking competitions. You sense David Braben is having a lot of fun.



\* Kickstarter has allowed David to constantly update backers about the progress of Elite: Dangerous.

**So now Elite is back with Elite: Dangerous, exactly 30 years on. You've said this game is intricate and will take time to learn and appreciate. Is this a game for the hardcore gamer?**

This is a game again for, dare I say it, me. It's for people like me. A lot of these things [are about] courage of convictions: what sort of game would I like to play and are there other people out there like me? And I don't mean my age. We've shown [it] of people going all the way down to teenagers and all the way up to my age and older. What we've found is that people want a good game and they think this is a good game.

**Did you get an indication of the profile of players from the Kickstarter campaign?**

I think a lot of people following the game were older players or older

people who remembered the game like me. But certainly when we went to America at GDC and then again for E3, we were seeing more players coming to the game who hadn't heard of either of the originals whereas previously people were saying "I loved Frontier" or "I loved Elite" or "I loved both". When we were actually getting more players coming in who didn't know the game, that was very heartening.

**Elite has always been more popular in the UK and Europe, hasn't it?**

Yes. I think the original game got a lot less coverage in the US and they didn't necessarily go well on the platforms that were available in the US. The original Elite took quite a while to move to the Apple II, which was a key platform in the US, whereas the BBC Micro hardly had any footprint in the US.

**Why did you decide to go down the crowdfunding route?**

I wanted very much to know this game would work and I think without the huge vote of confidence from the crowdfunding people we wouldn't have been able to do it, simple as that. I'd get lots of emails prior to the crowdfunding, saying "you must do a new Elite" and all

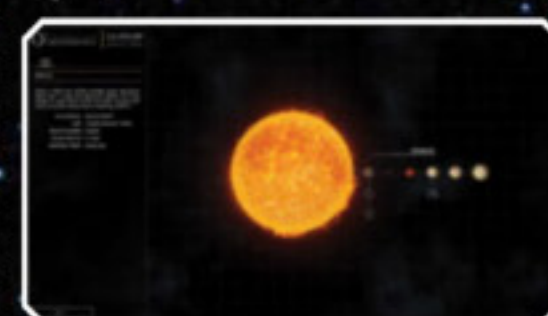

\* [PC] Some of the included planets have been named by Kickstarter backers. Maybe you'll find yours.



## WHY I LOVE ELITE

Pursuit of 'Elite' status meant happily blasting anyone with the temerity to interfere when jump-driving towards my latest destination. Pirates, fellow smugglers, Thargoids, cops and civilians – all just notches on the laser cannons. And all in vain, since despite countless hours on four platforms I never persevered beyond 'Deadly'...

**IAN MALCOLM,**  
LEAD DESIGNER AT  
MELBOURNE HOUSE



of this sort of thing, and it's difficult to know whether that's 100 or so very vocal people or whether they're actually representative of a much, much bigger silent majority.

**You've said that you'd wanted to create this particular game for quite some time, but why didn't you?**  
It's an ambitious project, which means it's quite expensive to make and it needs quite a lot of people. I think to be able to do that you either need the backing of resources from a publisher, because one of the problems [is] getting it to market and getting visibility of the game, or you try something like Kickstarter.

**Have you learned a lot in the time between the third Elite instalment and this game?**

Yes. One of the things that we did quite early on, in 2008, was release a game called *Lost Winds*, which was really good for us because it was the first time we'd tested out our own processes. It's all very well to say

in the pub, "yes, we could do that, how hard could it be? We could do it easily," but it's much harder and braver to actually try and do it. So with *Lost Winds*, we promoted the game ourselves, spoke directly to magazines and websites, and we sold the game digitally through the Nintendo Store initially. We managed milestones internally and all that sort of thing, and it worked really well. It was less of an overhead than working with a publisher. So we used that experience, we did another game, *Coaster Crazy*, which we learnt a lot from again and that's built up internally the knowledge

\* [PC] Graphically Elite: Dangerous is amazing. Time for a new PC!



## WHY I LOVE ELITE

Elite was the first game I got really addicted to [and I] kept playing... into the early hours. I'd get to school the next day, tired [and] whenever I shut my eyes I'd see the crosshair and police ships swarming around me, jolting me awake!

**STE PICKFORD**



that we feel we need to go much bigger.

**So the stars have lined up for you with Elite: Dangerous?**

I think the stars lined up for us in a different way, in the sense that it's now practical to sell a game the size of *Elite: Dangerous* online, whereas even back in 2008 I think it would have been a big ask, for a download of a gigabyte or so, because the network infrastructure wasn't there, whereas now it is. So I think what's happened is the world has changed to enable this.

**What elements are in Dangerous that you wish you'd put in before?**

The main thing [is] the fact that you are online – you are playing both with and against other players, other humans – really adds such a lot to it. And I think there are a lot of knock-on effects of that. We've seen a lot of YouTube videos of quite amazing operations and people doing things that I hadn't expected. Some of the smuggling videos I've seen are excellent. Some of the things that people have discovered in the game are also great. It shows such a love for the game and some of the time-lapse photography people have been taking are brilliant. ★

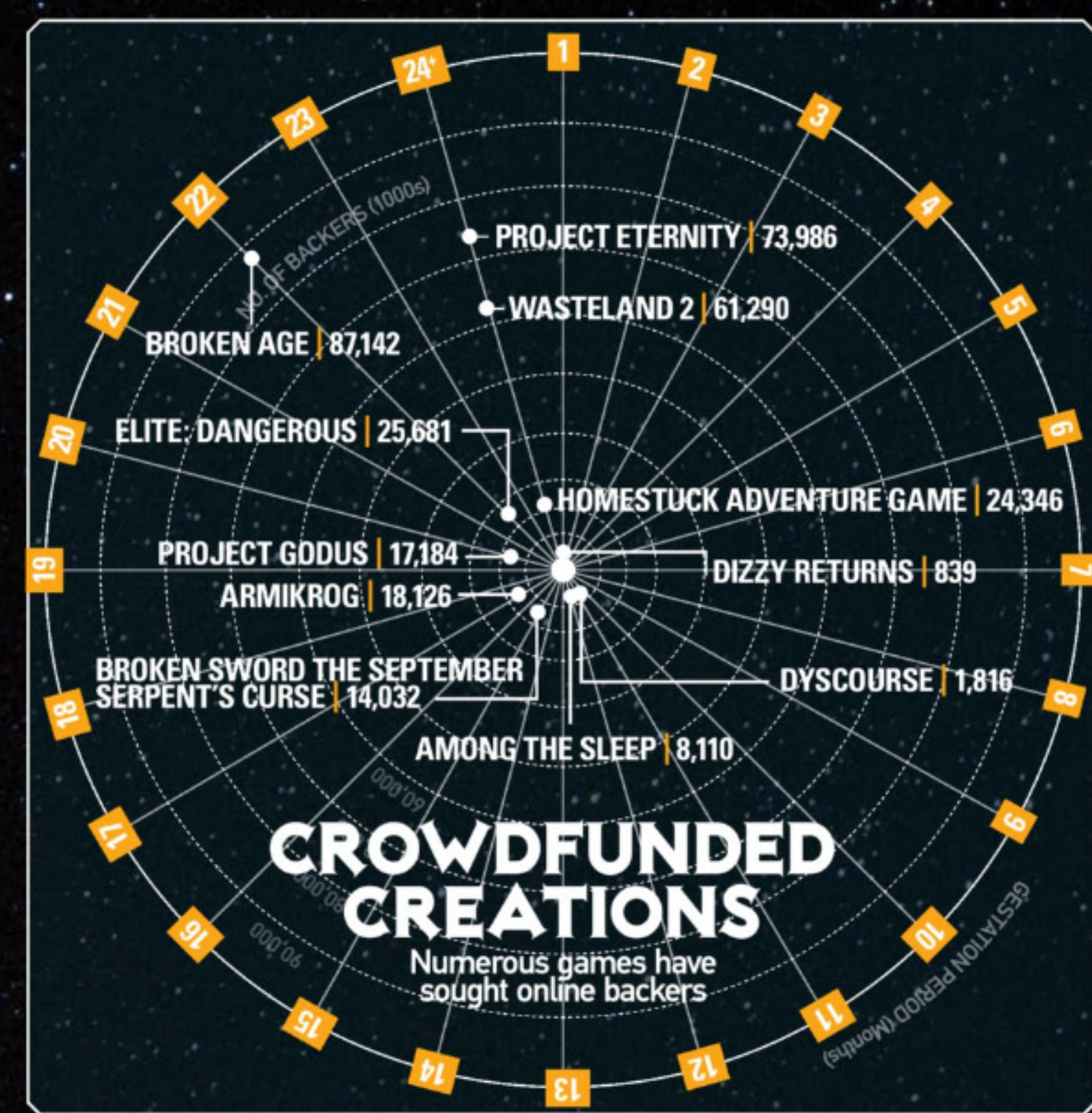

It's an ambitious project, which means it's quite expensive to make

David explains why the new Elite game has taken so long



\* [PC] The ships have been completely updated and look incredible. We can't wait to take this one into space.



\* [PC] Elite: Dangerous is absolutely huge in size and scope. You'll be playing it for years.



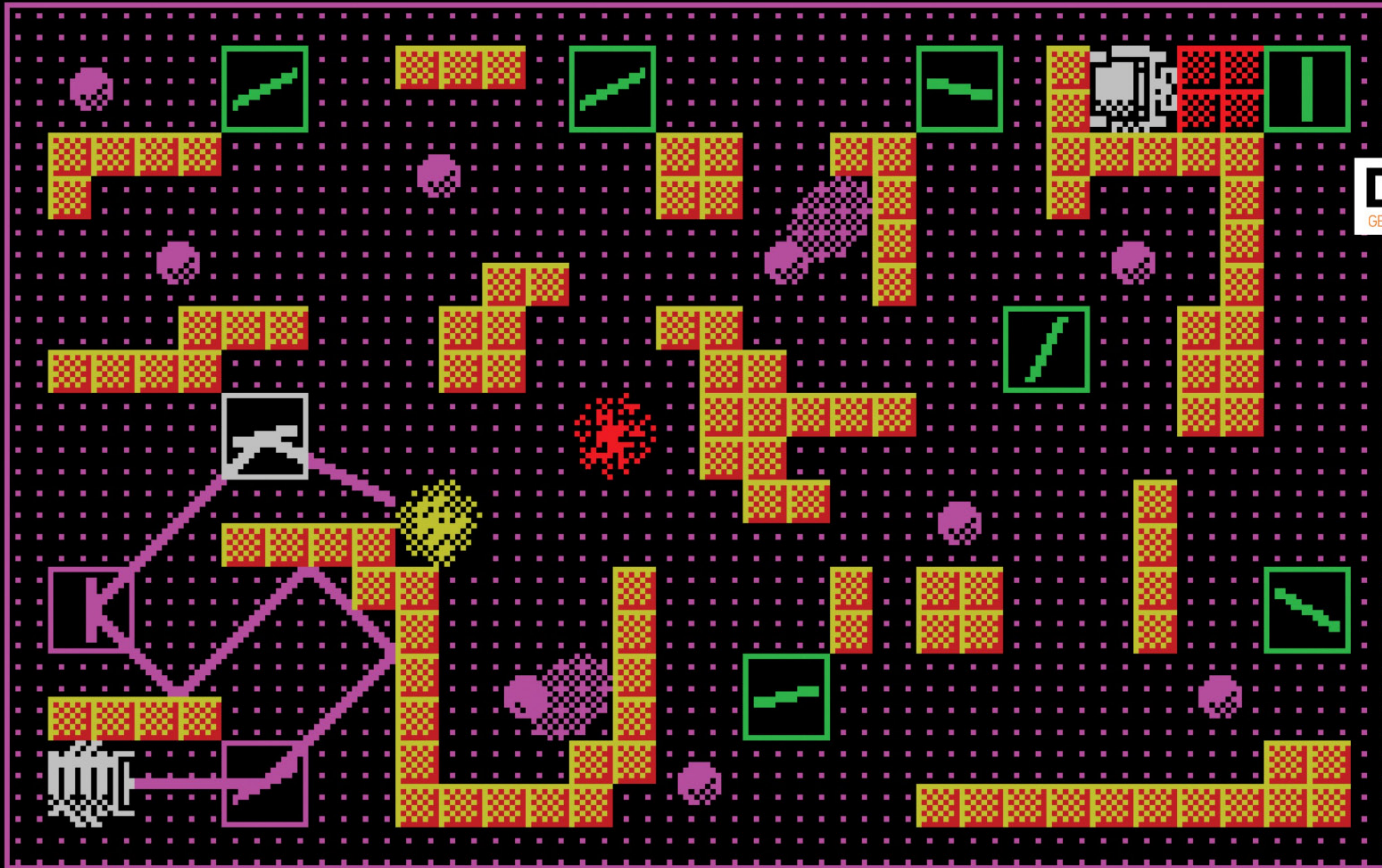

# Deflektor

GET THE GREMLINS!

RETROREVIEWAL



• ZX SPECTRUM  
 • VORTEX SOFTWARE  
 • 1987  
**Often, innovative games can look tired as the years go by.**

If an original game attracts any kind of attention, it's usually not long before imitators emerge and the sequel machine kicks into action. Inevitably, some of those will improve upon the original and the genre will develop until the original game looks rather plain. If you don't believe us, try playing the original *Street Fighter* sometime. However, some games received little enough elaboration that they became immune to this effect, and *Deflektor* was one of them.

*Deflektor* is the kind of puzzle game you'll try to approach methodically at first, as the laser beam needs to take some very complex paths to destroy all the nodes required to clear each stage. However, the energy bar which serves to limit your time drains quite quickly, and if the overload bar begins to fill because you've directed your beam at some spikes or back at its source, you'll need to act quickly to prevent yourself from losing a life and starting again. As a result, it's much more of an action-puzzler than it would appear to be.

Though it was well received by the press and publisher Gremlin Graphics later released the very similar game *Mindbender*, clones and copies of *Deflektor* weren't common, which helps it feel magnificently fresh today. In fact, the idea is so good that lots of iOS and Android developers seem to be drawing inspiration from it, so savour that fresh feeling while you can. ★

LEVEL - 07

COMPUTER

GREMLINS! ♦ ♦ ♦

LIVES



OVERLOAD



ENERGY



SCORE

23590

HIGH

90000

# Ranarama

Steve Turner was inspired by Dungeons & Dragons when designing Ranarama. But, as he tells Rory Milne, a greater influence on his classic dungeon crawler was partner Andrew Braybrook's C64 hit Paradroid



## THE MAKING OF: RANARAMA



» [ZX Spectrum] Black iconic symbols called 'glyphs' give your sorcerer access to various magic when activated.



The earliest memories Steve Turner has of *Ranarama's* development relate to the three games that influenced

his title's design and Graftgold settling into a new workplace. "At the time, Andrew [Braybrook] and I had moved into a little office on the back of my house. There was just room for our two desks and leather executive chairs. At first, I was playing around with the look of a Spectrum version of *Paradroid*. The idea from the start was to borrow the gameplay and put in a different scenario. I thought *Paradroid* was a really good design [and] so worth reusing. I [copied] its bas-relief effect [and] decided that scrolling was too limiting on the Spectrum, so I experimented with the flick-screen approach. Andrew and I used to play *Dungeons & Dragons*, which seemed a good idea for the scenario. I liked the way you drew a map as you explored in D&D, and thought I would hide rooms [in *Ranarama*] until you had explored them. I saw *Gauntlet* probably just once, soon after I started... It reinforced the idea I had for the scenario, suggesting I was going in the right direction."

Having found inspiration, Steve reduced his game's potential development time by repurposing existing code and investing in hardware. "We always started by stripping the last game down to a reusable shell and then adding improvements. These were ideas we had that we hadn't had time or room to try out. The graphics routines

probably changed the most. I bought two PCs for Andrew and, if I remember correctly, *Ranarama* was the first program I wrote using [mine]. I used a Z80 cross assembler from a company called Avocet. I worked out that if you changed one connection to the I/O chip on a Spectrum Centronics printer interface, it became a programmable input/output interface. I could then use the parallel port on the PC to output hex code to the Spectrum. All I needed was a boot program on the Speccy to

**"I used to sketch the graphics on a pad of squared paper, then convert them to hex"**

Steve Turner eschewed a graphics editor

download the hex. This system really worked fast and was so much better than typing on a Spectrum."

With coding foundations in place, Steve's focus moved to his game's aesthetics with efficient design and implementation of its 'shadowed' bas-relief visuals being a top priority. "I tended to put graphics in after I had coded large portions of the game. The main look came from the Spectrum's limits. I wanted – in contrast to *Quazatron* – to get colour on the screen, which had to be limited to character-size blocks. The floors were the only part of the screen with sprites moving over them, so they were drawn with two colours to avoid colour clashes. To

make up for this the walls were really brightly coloured. I used to sketch the graphics on a pad of squared paper in light pencil, and colour in the squares, then I used to convert them to hex. I got so quick at this I preferred it to using an editor. I had a pretty good idea of the look of rooms early on. I can remember Andrew helping and coming up with the colour schemes and some ideas for the room graphics. The shadow effect was there to enhance the solid wall effect. The graphics were all worked

out by an algorithm to save all the time of creating graphics maps. I put in data defining room sizes and door positions and the Spectrum chose the correct wall pieces and floor/shadow pieces. Then the data could be very small so I could cram the whole game in one load."

**In an example of form following function, Steve's graphic design defined his game's hero, which in turn helped him name**

his project. "The main character was going to be a young trainee wizard. I tried many times to draw him top-down, but in the resolution and size I wanted I just couldn't make him clear enough. I used to have David Attenborough's book *Life On Earth* and on the cover was this cute green tree frog. I wanted a shape that could be recognised top-down and tried it out. Rana is the Latin for frog; I think that came from the same book. *Ranarama* was a play on *Bananarama* who were in the charts a lot. I knew [when] writing original



### IN THE KNOW

- » PUBLISHER: HEWSON CONSULTANTS
- » DEVELOPER: GRAFTGOLD
- » RELEASED: 1987
- » PLATFORM: VARIOUS
- » GENRE: DUNGEON CRAWLER

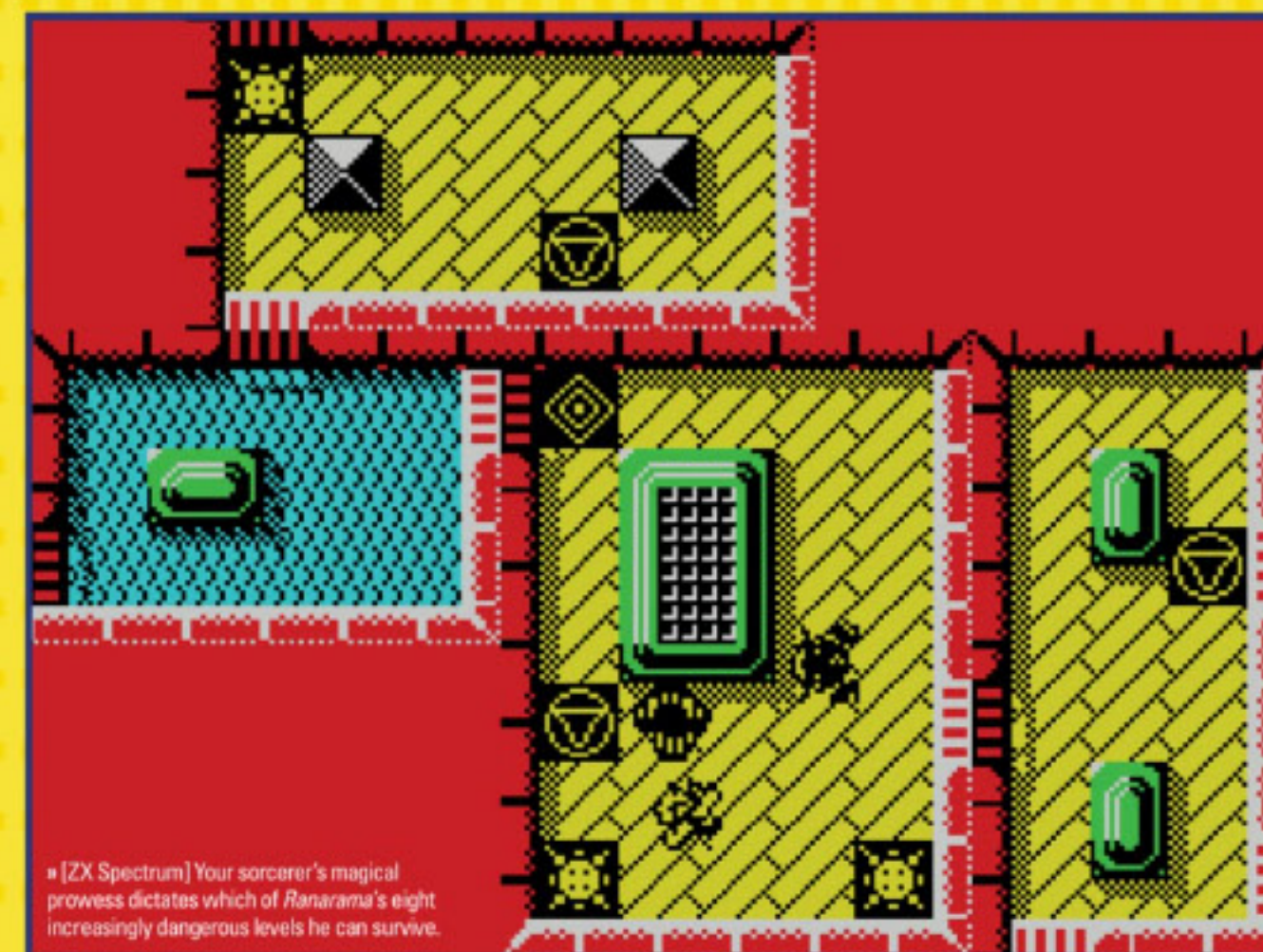

» [ZX Spectrum] Your sorcerer's magical prowess dictates which of *Ranarama's* eight increasingly dangerous levels he can survive.

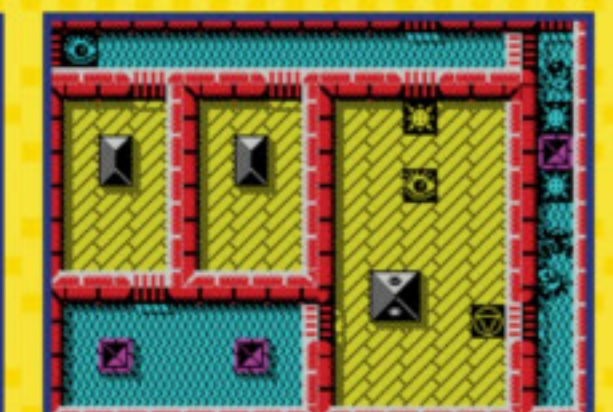

» [ZX Spectrum] Narrow corridor-like dungeons are often hard to negotiate without enemies draining your power.

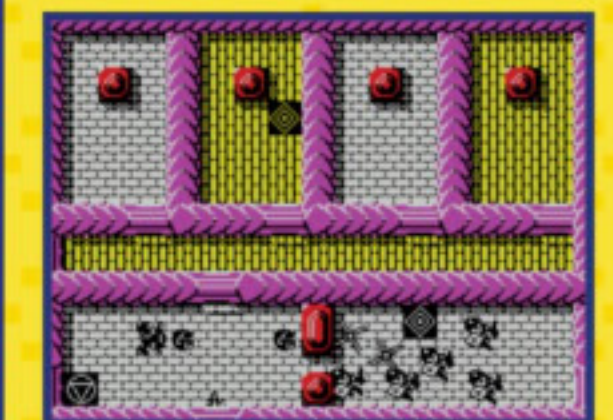

» [ZX Spectrum] Certain 'glyphs' act as portals between levels, but each leads to a different destination.



# AMPHIBIAN ANTICS

Other notable videogame frogs and toads

## FROGGER

■ One of gaming's first amphibian protagonists, Konami's Frogger was so popular on release that his eponymous outing spawned countless clones. Frogger's perilous journeys across busy roads and predator-infested rivers remain just as challenging today.



## COSMIC WARTOAD

■ 8-bit auteurs Denton Designs based *Cosmic Wartoad* – the character and the game – on ideas from artist Simon Butler. Their warty hero faces an attractive but demanding series of shoot-'em-ups linked by an overall objective of collecting a toolset and keys.



## FROG MARIO

■ More of a fat plumber in a frog suit than an actual videogame amphibian, but Frog Mario still qualifies. In *Super Mario Bros 3*, Mario's frog suit is obtained from a Toad Shop and bestows superior swimming and hopping abilities on the moustachioed one.



## BATTLETOADS

■ Rare's anthropomorphic trio started out brawling on the NES and graced many other popular home systems before appearing in the arcades in their last, and arguably greatest, game. Like most Nineties animal mascots, the 'toads exude attitude.



## SUPERFROG

■ A menagerie of cute-but-cool animal platformers followed in the wake of *Sonic The Hedgehog*, but Team 17's hero has solid, considered gameplay under his cape. Mechanically, *Superfrog* behaves as much like *Bomb Jack* as *Sonic*, which works surprisingly well.



## SLIPPY TOAD

■ He's annoying when he's ribbiting in your ear as you're barrel-rolling out of danger, but Slippy Toad is a fixture of the *Star Fox* series, a valued wingman and the brains of the team. Based loosely on assistant director Yoichi Yamada, he's also technically a frog!

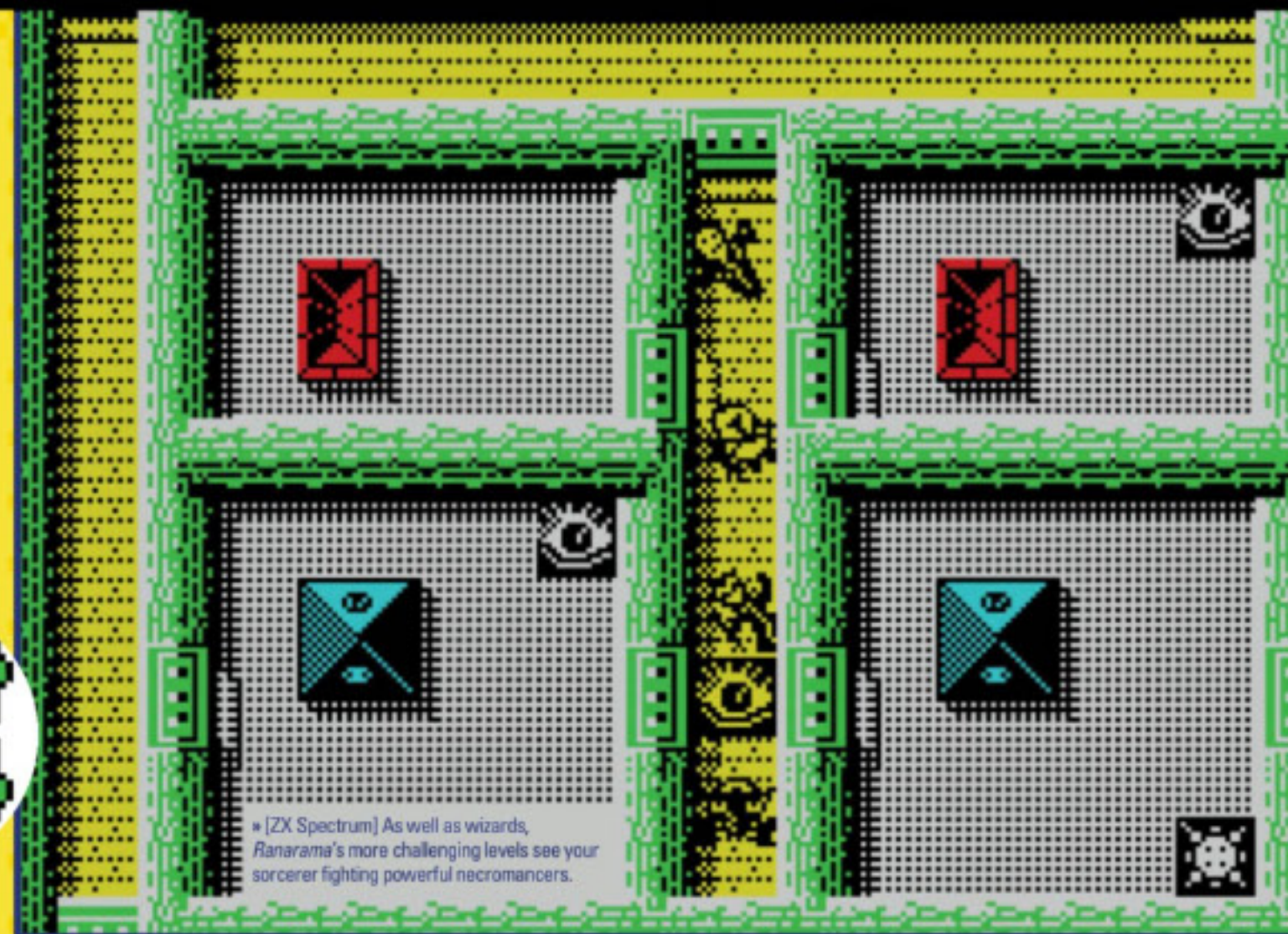

■ [ZX Spectrum] As well as wizards, *Ranarama's* more challenging levels see your sorcerer fighting powerful necromancers.

titles you needed something catchy that people would remember."

As *Ranarama* took shape, Steve developed sprawling dungeons and the game's distinctive hidden-room mechanic. "At first, the map designs were a case of trial and error to see what worked. I liked the idea of the rooms opening up as you entered, as it added a sense of achievement and knowing you had explored... Smaller rooms made it more interesting as it constricted the player. I experimented with long thin tunnels, small rooms and more open spaces and tried to give the levels light and shade by varying the style of layout. I wanted hidden rooms early in the design. The player [needed] to be able to work out where a hidden thing [was] or it [would] get very boring having to look everywhere. The revealing [of] explored rooms made hidden rooms work. All I had to do was to leave some unused areas on each map so the hidden rooms were not too obvious."

Gameplay refinements followed, with Steve opting to appropriate and expand on *Paradroid's* grading system and control mode, and to make *Ranarama* more accessible than his previous fantasy titles. "I wanted a more immediate game. While *Avalon* and *Dragonorc* were very popular, they

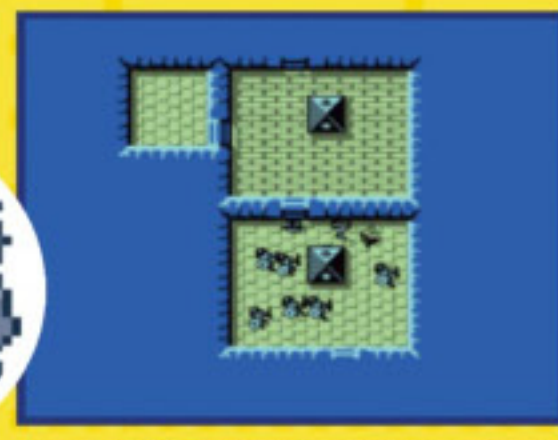

■ [Amstrad CPC] The Amstrad port was extremely similar to the Spectrum outing with slightly better audio.

were not liked by out-and-out arcade players – I wanted to appeal to as many players as possible. The beginning of the 'eight level' [grading] system was Andrew's system of weapons and damage from *Paradroid*. I started off with defence and attack and then applied the same system and settled on a finite number of distinct steps to make it manageable. I wanted something for the player to collect and this evolved into the spell system. I wanted a progression of the player rather than [them] just taking over the enemy warlock – some way of taking some of the enemies' powers for a limited time. I thought that I would generate upgrade pick-ups when the enemy dies; I then thought it would give extra depth to put in the spell system. The floor glyphs were

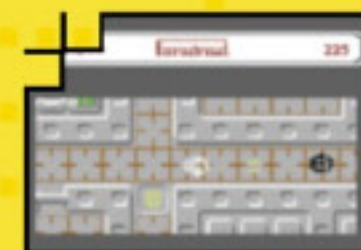

**DEVELOPER HIGHLIGHTS**  
**PARADROID** (PICTURED)  
SYSTEM: C64  
YEAR: 1985  
**QUAZATRON**  
SYSTEM: SPECTRUM  
YEAR: 1986  
**URIDIUM**  
SYSTEM: C64  
YEAR: 1986

## “It was when I came up with the name [Ranarama] that the idea of an anagram hit me”

Steve explains his inspiration for the sub-game concept



■ [ZX Spectrum] Your sorcerer's amassed spells are listed upon activating a symbol known as the 'Glyph Of Sorcery'.



# THE MAKING OF: RANARAMA

## TURNER'S TRIUMPHS

More classics from Steve Turner's back catalogue



### DRAGONORC

SYSTEM: Spectrum  
YEAR: 1985

■ An RPG that plays like an arcade adventure, Steve's massive, and massively complex, sequel to *Avalon* is more approachable than its predecessor but just as cryptic. *Dragonorc's* puzzles require committed lateral and abstract thinking, making its completion a serious challenge.



### QUAZATRON

SYSTEM: Spectrum  
YEAR: 1986

■ Steve's clever amalgam of isometric graphics and the underlying gameplay of Andrew Braybrook's masterpiece *Paradroid* works better than a straight Spectrum port would have. *Quazatron* feels more open-world than *Paradroid*, but retains its inspiration's brilliant mechanics.



### MAGNETRON

SYSTEM: Spectrum, C64  
YEAR: 1988

■ This follow-up to *Quazatron* boasts several improvements to the established formula, delivering more detailed and colourful graphics, a gameplay tweak involving deactivating reactors and a new grapple system. While superficially similar, *Magnetron* has a quite different feel to *Quazatron*.



### INTENSITY

SYSTEM: Spectrum  
YEAR: 1988

■ A straight conversion of Andrew Braybrook's C64 curiosity, Steve and artist John Cumming's adaptation is as faithful as could be. Concessions are made to colour and sound, but the frantic colonist-rescuing and alien-exterminating from Andrew's genre-defying original remain intact.



### SUPER OFF ROAD

SYSTEM: Spectrum, Amstrad  
YEAR: 1990

■ Another collaboration with John Cumming, Steve's *Super Off Road* successfully captures the bright colours and frenetic pace of the Leland coin-op. Most easily described as an isometric *Super Sprint* with nitro-enhanced trucks, the game is best appreciated in multiplayer mode.



### VIROCOPI

SYSTEM: Amiga  
YEAR: 1995

■ A spiritual successor to *Quazatron* of sorts – its main character D.A.V.E. is based on KLP2 – *Virocop* received generally positive reviews but suffered disappointing sales. This is a shame, as *Virocop* is a challenging and polished top-down maze shooter with well-constructed mechanics.

■ [ZX Spectrum] Strategy plays a vital part in *Ranarama's* gameplay, but tight spots require a quick trigger-finger.



■ [ZX Spectrum] On defeating the last warlock on each of *Ranarama's* levels, their dungeons turn a murky blue.



■ [ZX Spectrum] Combat with warlocks involves solving an anagram of the word 'Ranarama' against the clock.



a neat extension of the control mode [in] *Paradroid*. When the player is standing on a glyph, the fire button does something different – [glyphs] were just magic versions of *Paradroid's* terminal and lifts. I had always planned on a multilevel map emulating the *Paradroid* decks; [Ranarama's] map filled in as you explored so you could work out where there may be a secret passage or room. The enemies were placed by computer – that saved a lot of work. To make it interesting, I placed the captains and then randomly surrounded them with troops. That way, it was a fractal distribution with quiet spots and hot spots. I gave them a bit of intelligence by marking each door the player used and the way he went so the enemy could stalk the player."

*Paradroid's* combative sub-game concept would also make it into *Ranarama*, although Steve dropped an ambitious initial concept in favour of deciphering anagrams against the clock. Another Andrew Braybrook program, *Abmon*, proved useful for fine-tuning *Ranarama's* sounds – including a 'croak' to signal its hero's failing health. "I

had been playing around with a game rather like curling, where each wizard rolled magic balls onto a playfield... The trouble was [that I] never worked out the objective, only that you could defend or attack by placing the balls and they'd kind of chain-react when they hit one another. I wanted it to be quick to keep up the pace of the game. It was when I came up with the name [Ranarama] that the idea of an anagram hit me. As the name had many letters the same, it made it much easier [and] so could be very quick. It also reinforced the name of the game... The sound routine was there from the beginning, so I usually put some placeholder sounds in quite early on. These were then tuned up by altering numbers using [Abmon]. We liked to do things in different ways; the energy bar was a bit of a cliché. I needed something to alert the player he was in trouble – a little sound. I didn't mind writing music for the Spectrum as I got a good tone out of it by playing two notes simultaneously. I used to get fed up if reviews marked my games down for not having in-game music; I preferred sound effects."

Although Steve had taken *Ranarama* from concept to completion in just six months, its release would be delayed. "Most of the game just fell into place very quickly apart from the sub-game. That was the beauty of reusing *Paradroid's* game design. But [it] was delayed as Andrew Hewson wanted to release on Amstrad and C64 at the same time. He commissioned an Amstrad version, but the girl doing it just didn't come up with anything. I eventually took [it] over and started from scratch. I raced to complete it so the release was not delayed any more. I did visit Gary Foreman a couple of times for the C64 version... I didn't do any of the programming but documented every game routine [to] give Gary the best start. I think the delay really damaged sales as many *Gauntlet* clones – including an official one – were released before *Ranarama*. I could have been the first and set the standard. At the time of *Ranarama*, it [was] really hard to make a game that excited magazine reviewers who were playing around with Amigas and Ataris."

When *Ranarama* did later appear on the Atari ST, Steve – who played no part in its creation – felt it didn't take full advantage of the hardware. "I was disappointed as the game was a code conversion rather than a proper ST version. Originally it had 8-bit graphics from one of the other versions, [but] John Cumming at Hewson thought they looked poor and changed some of them. I didn't like the way the animation rate had not been tuned to the faster speed of the Atari ST – so the frog jerked around."

Looking back now, Steve expresses satisfaction with *Ranarama* but surprise at its continued popularity. "It's one of the few games where I had no wish to change it afterwards – adding any more complication would be detrimental. I didn't think any of the games would be remembered after a year or two, as they had such a short shelf life, but I am proud of what I achieved given the limitations of the Spectrum." ★

Many thanks to Steve Turner for sharing his memories of *Ranarama* and Graftgold.

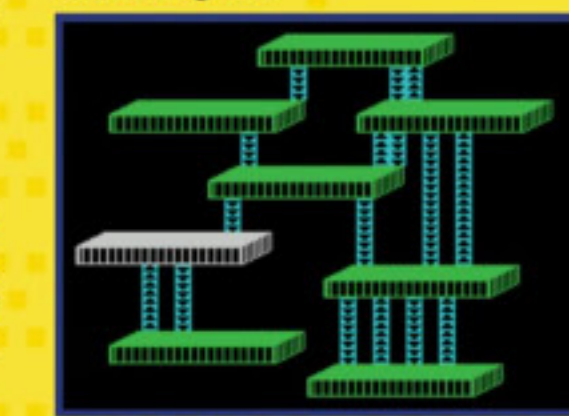

■ [ZX Spectrum] 'Glyphs Of Travel' – iconic symbols – display the levels they allow your sorcerer to travel to.

# The Greatest Gifts EVER!

As Christmas trees go up in homes across the land, Paul Drury asks game developers about their most memorable game-related gifts

Perhaps it was unwrapping an Atari VCS in the Seventies, or a Commodore 64 in the Eighties or being ecstatic that somehow your doting parents had managed to

track down a copy of *Ocarina Of Time* for Christmas 1998. The memory of racing downstairs on Christmas morning and finding just what you wanted under the tree can last a lifetime, as can the misery of discovering Santa doesn't know you at all and has brought you an Oric instead of the Spectrum you had clearly put on your list. We asked famous game developers for their highs and lows of Christmases past... and some even sent us photos of their treasured presents. \*

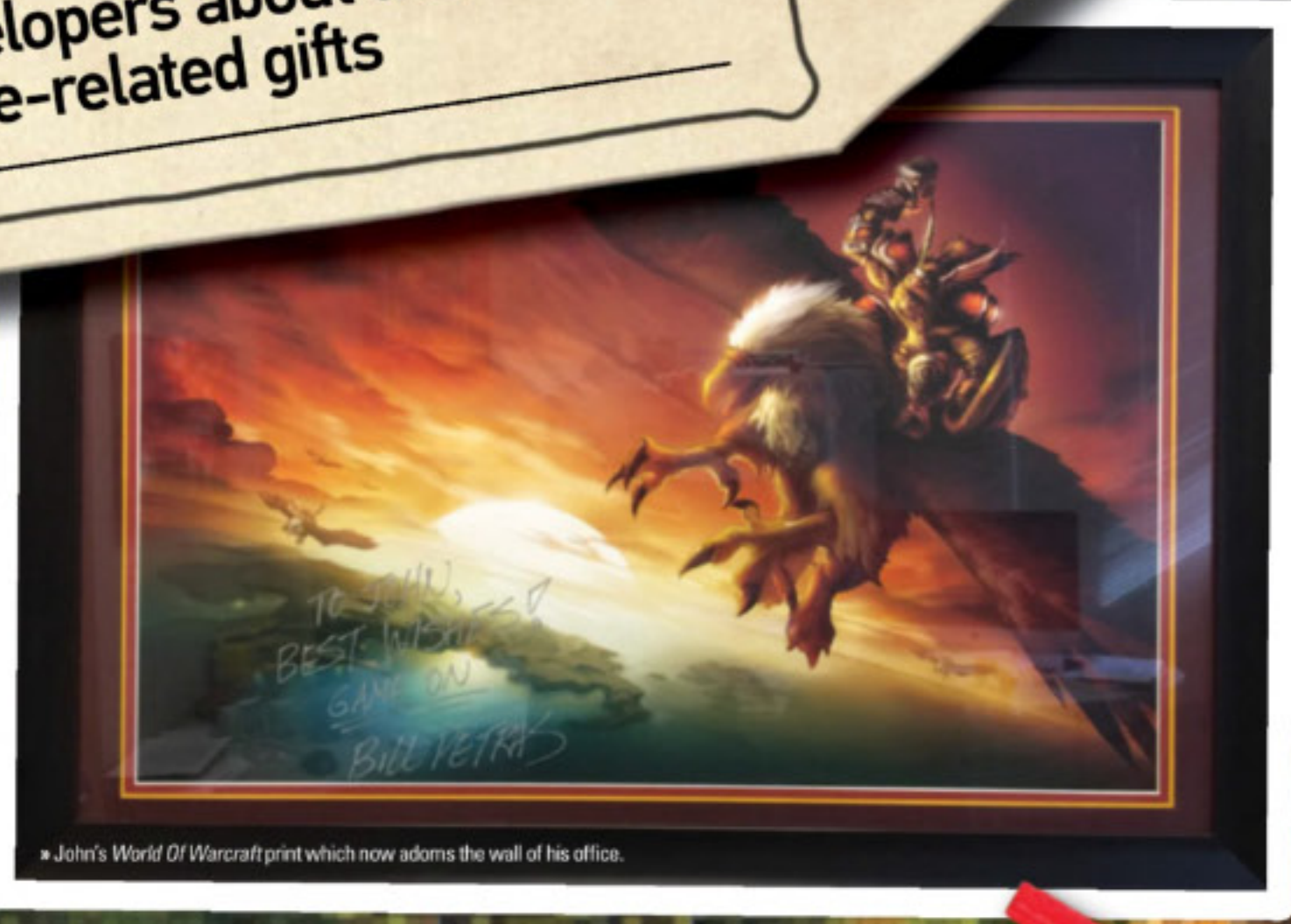

John's *World Of Warcraft* print which now adorns the wall of his office.

## Matthew Smith

(MANIC MINER, JET SET WILLY)

Anything I got for Christmas was usually the result of hard-nosed negotiation with my parents, but the TRS-80 I got in 1979 was a surprise. I can still remember the smell of it when I opened the box. The most influential present I ever got was also by Tandy – a Science Fair 65-in-1 kit for Christmas 1974. No, I haven't still got it but I think I'm gonna get one off eBay now you've reminded me...



## John Romero

(DOOM, QUAKE)

For Christmas a few years ago, Brenda (my wife) got autographed and framed the original print of artwork by Bill Petras that was used to set the visual style for *World Of Warcraft*. It's the painting where the dwarf is riding an eagle, and it tells you so much about the spirit of the game. It was over our hearth for years and now it's in our office. Absolutely love that game.

## Nick Pelling

(FRAKI, FIRETRACK)

A Duke Nukem statuette. It is just awesome. I must have got it, coo, Christmas 1833? I don't remember. 1998 I think. Of course I've still got it. It's proudly on display in a cupboard somewhere.



Two badass dudes. Nick is on the right in case you were wondering...



A young Matthew Smith, a few years before Tandy changed his life forever.

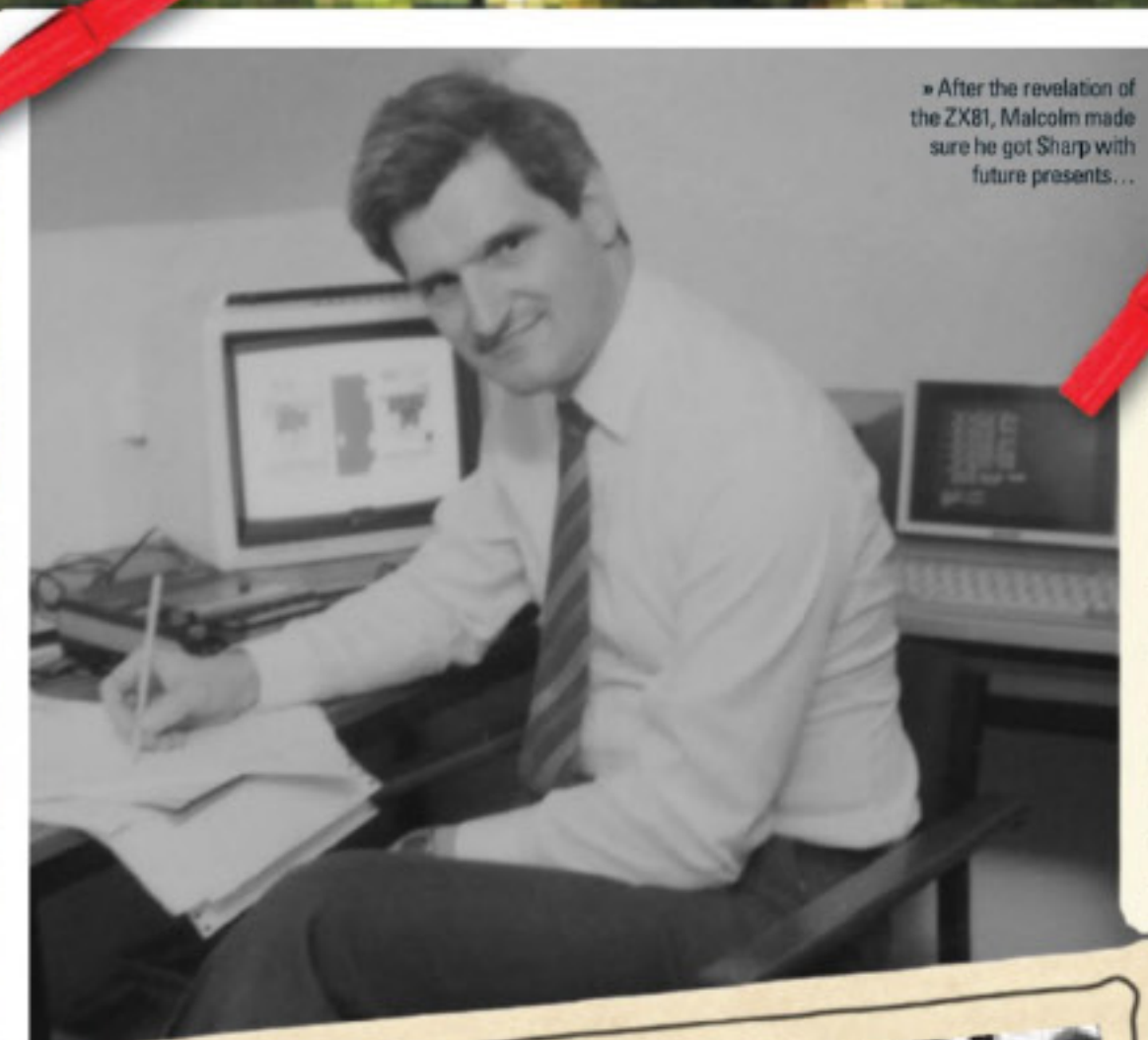

After the revelation of the ZX81, Malcolm made sure he got Sharp with future presents...

## Malcolm Evans

(3D MONSTER MAZE, TRASHMAN)

You forget I was Father Christmas merrily eating mince pies and slurping sherry long before home computers came out, though my first ZX81 was indeed a present. It was bought for me by my wife on my birthday, in April 1982. I had been to a careers advice organisation and after many hours of tests I was told I was too old for the software game and I was better off in the rut I was in – hardware design. She knew I was keen to get into software, but the ZX81 was still a real surprise.



© Even-Amos

THE GREATEST GIFTS EVER!

## Shahid Ahmad

(CHIMERA, PANDORA)

I didn't get any Christmas presents, coming from a family that didn't celebrate it, but the summer of 1982 felt like Christmas for me. My mum, who didn't have the money really, bought me an Atari 400. It was a profoundly generous act that changed my life. Opening that box was as close to Christmas as I got. The first thing I did was play *Star Raiders*, of course!



Shahid gazes lovingly at his post-Atari C64.

## Mark Healey

(LITTLE BIG PLANET, DUNGEON KEEPER)

Christmas 1983 or '84, when I was 12 or 13, I remember unwrapping a C64, and being full of excitement. There was something mumbled in the air about it being for the whole family – yeah, yeah, yeah whatever! I, sorry, WE, also got two games – *Centropods* by Rabbit Software and *Armageddon* by Ocean. I quickly got bored of the games and started devouring the rather thin, meagre user manual that came with it. I used to take it with me everywhere.

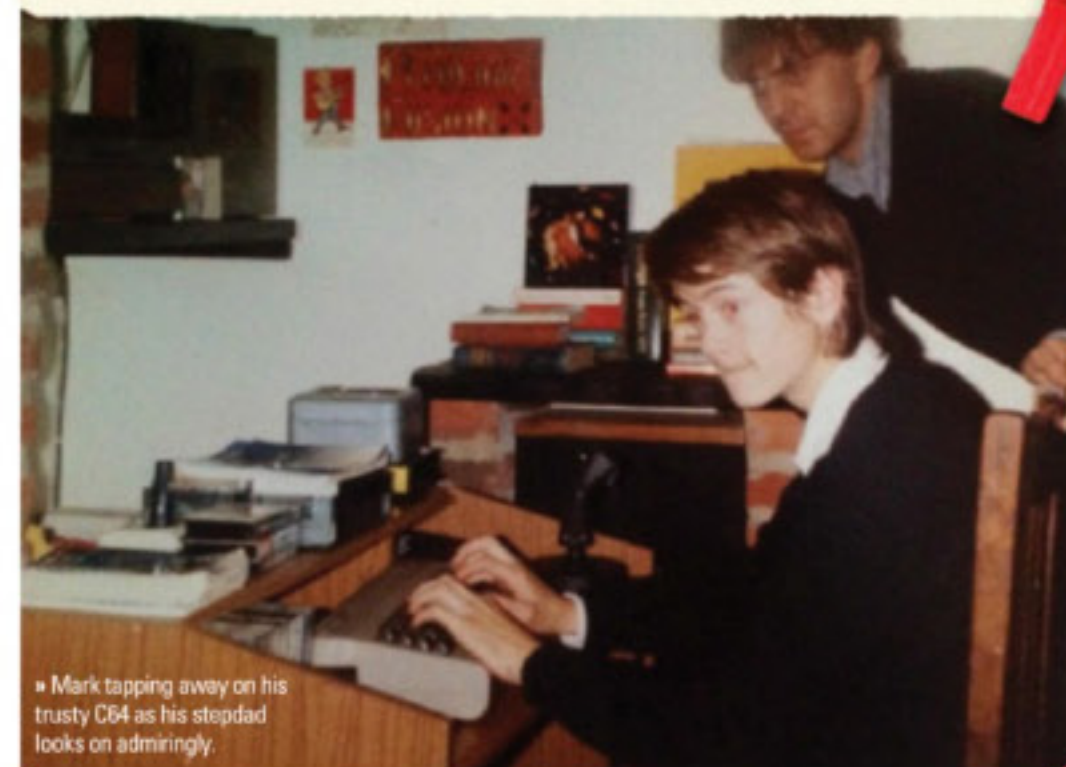

Mark tapping away on his trusty C64 as his stepdad looks on admiringly.

## Martin Hollis

(GOLDENEYE, PERFECT DARK)

Knowing that computers were going to be a big deal, at Christmas 1981 my parents bought a ZX81 for the family for the princely sum of £69. We plugged it in and switched it on but it didn't work. Mum and dad sent it back. Sinclair replaced it. Second one didn't work either. Same problem. Dead as a brick. So they said, well, perhaps we should pay a little more for a computer that actually works? Enter the BBC Micro...



Martin in the middle of mum and brother Richard as they play *The Magic Sword*, the Hollis family's debut release on the BBC Micro.

ULTIMATE GUIDE

# PUZZLE BOBBLE

“Once you pop, you can’t stop”. That’s Puzzle Bobble for sure. Or was it Pringles? Martyn Carroll looks back at the long-running series while trying to avoid further snack slogan confusion

**U**hat’s in a name? *Puzzle Bobble* was the original Japanese title and it was renamed *Bust-a-Move* in other regions. Neither title is ideal. Even though you’re matching colours, it’s no puzzle game. There’s no time to sit and ponder your next move, as you’re up against the clock or a competitor. You need to quickly aim your bubble gun and fire shots in phew, phew, phew fashion.

‘Bust-a-Move’, meanwhile, sounds like a dance game (indeed, there was a music title called *Bust-a-Move* released in Japan and released elsewhere as *Bust-a-Groove*). During production the game was known as ‘Bubble Buster’ and there’s even a title screen bearing that name concealed in the code. It may lack punch but Bubble Buster does a better job of describing the game.

So what is in a name? Not much really. It’s still a fantastic game regardless of its imperfect titles. To confuse matters, the ‘Puzzle Bobble’ name has been used outside of

• [Arcade] If a competitor stepped up, they could join in and trigger a two-player game at any time.



• [Arcade] Going head-to-head with an opponent in the legendary versus mode.



Japan, so for the purpose of this feature we’ll stick with the original title. And let’s face it, the game is a spin-off of *Bubble Bobble*, with the same characters, sounds, and overall cuteness factor, so Puzzle Bobble probably is the best fit.

The game arrived in Japanese arcades in 1994 and ran on Taito’s B System hardware, a 68000 board best known for powering *Rastan Saga II*, *Rambo III* and *Space Invaders DX*. The hardware was six years old at the time of the game’s release, but it was perfectly adequate for running what was a technically undemanding game.

*Puzzle Bobble* was strictly gameplay over graphics, where the basic concept was to clear the screen of bubbles by matching three or more of the same colour.

The single-player game was entertaining enough and featured a nifty scoring mechanic. You were awarded points for how quickly you could clear the screen and bonus points were awarded for ‘dropping’ bubbles (this was when you created a chain of bubbles and then popped the anchor point, causing the attached bubbles to fall out of play). Points were doubled for each bubble dropped, so if you were able to simultaneously drop 17 bubbles (the maximum) you would instantly score in excess of 1.3 million points.

## BUBBLE TROUBLE

Bubble Bobble baddies feature prominently in Puzzle Bobble. Just squint and look inside those coloured bubbles...

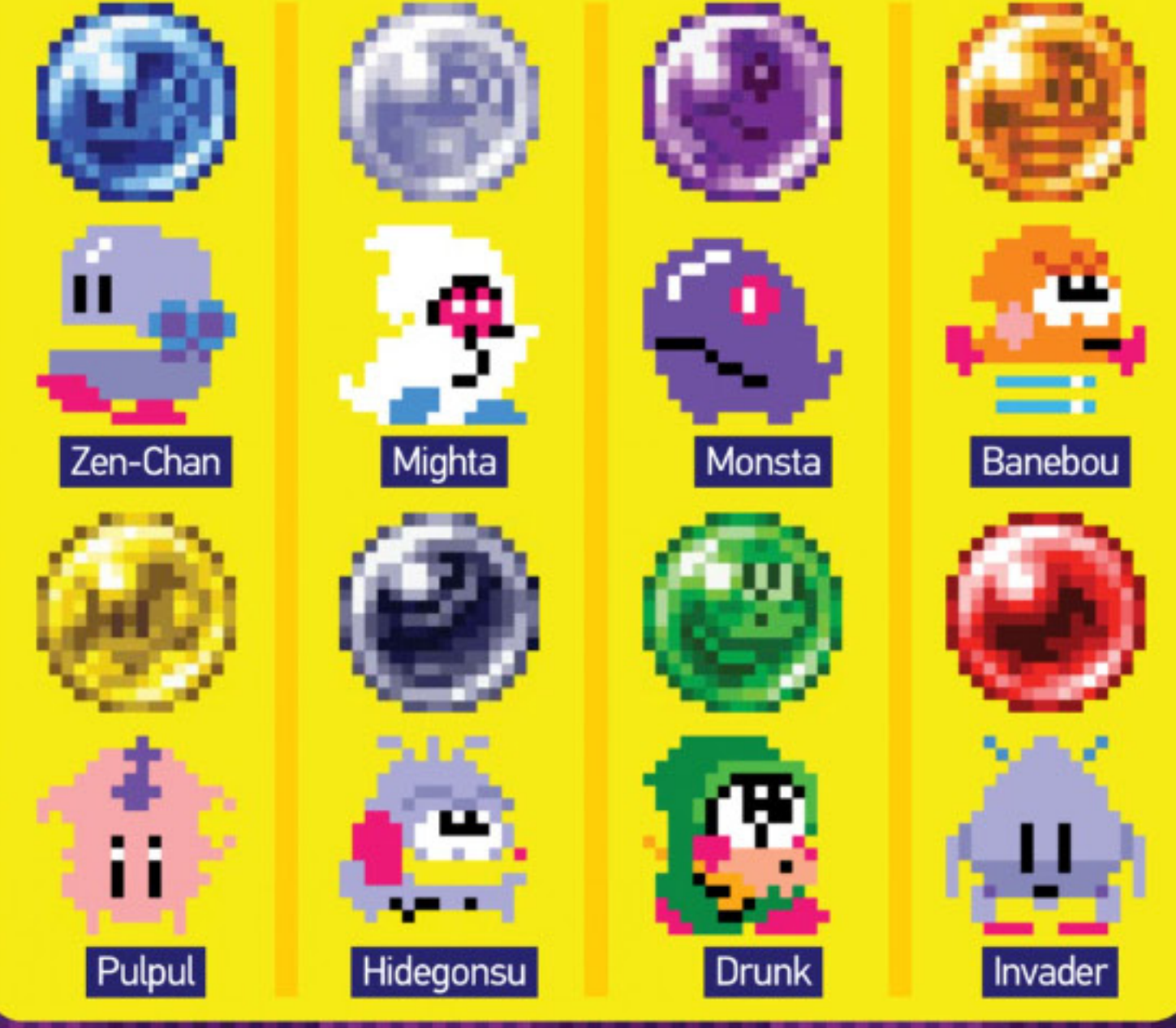

However, it was the split-screen versus mode where the real fun was to be found. Here, you competed against a second player in a Bub versus Bob survival battle – the loser was the first to have their bubbles pushed over the baseline at the bottom of the screen. The key to winning was to drop rather than pop, as dropped bubbles would be pinged over to your rival’s playfield. Of course, they

“The key to winning was to drop rather than pop, as dropped bubbles would be pinged over to your rival’s playfield”



• [3DO] The home versions introduced single-player battles, with the CPU in the guise of various *Bubble Bobble* baddies.

NEXT

TOTAL

NEXT

► could then return the favour, leading to much toing and froing, and quite possibly shouting and swearing. It could get rather tense when you were running out of room, waiting for a certain colour bubble that would buy you some breathing space (on the assumption you could actually make the shot, possibly by bouncing it off the wall), and then the screen started shaking to announce it was about to descent a row. Poppin' hell!

*Puzzle Bobble* quickly established itself as a classic two-player coin-op and its reach increased. In late 1994 it was licensed for release on the Neo Geo MVS arcade system. This version was essentially the same as the Taito original, except that it featured stereo sound and was released internationally so the 'Bust-a-Move' moniker made its first appearance. The following



► [Arcade] The US version of *Puzzle Bobble 2*, renamed *Bust-a-Move Again!*, ditched all traces of Bub and Bob.

year it was ported to the Neo Geo CD home console with the main addition being a difficulty select feature. More considered versions were released for the PC, 3DO, SNES and Game Gear (with a WonderSwan version arriving several years later). On these platforms a key feature missing from the original was addressed – you could now pit



► [SNES] Taking on Super Drink on the 100th and final stage. You had to weaken his defences.

“Further games quickly followed and each would merely tweak the winning formula”



► [Arcade] *Puzzle Bobble 2* premiered widescreen puzzles packed with bubbles.

yourself against the computer in versus mode.

The single-player game was also beefed up with a total of 100 rounds (the arcade had just 30) and a final battle against Super Drunk (aka Grumple Grommit), the main boss from *Bubble Bobble*. In addition, the various elemental bubbles from *Bubble Bobble* made an appearance in some single-player rounds: fire, for instance, would ignite and destroy nearby bubbles, and lightning would zap every bubble on the same row.

An arcade sequel also arrived in 1995 and ran on Taito's F3 hardware. Like the home versions of the original, *Puzzle Bobble 2* introduced CPU versus play (where you battled various characters including some *Bubble Bobble* stalwarts and some new ones) and added extra rounds and features to the single-player mode. Elemental bubbles did not feature, but some special bubbles were added to the mix, such as the star bubble which popped all of same-coloured bubbles. Some playfields were also expanded to fill the width of the screen.

The game would later make the jump to Neo Geo coin-op hardware, but it was the home conversions of *Puzzle Bobble 2* that really cemented the popularity

## SPIN SPIN SUGAR

Some more of the sweetest spin-offs in videogame history



### Parodius

Konami earnestly redefined the modern shoot-'em-up with the classic *Gradius* series, and then sent up the whole thing with the gloriously silly *Parodius* spin-off. And this wasn't just a trivial one-off, as the original MSX game was superseded with multiple entries for both coin-op and console.



### Final Fight

Initially developed as a follow-up to the original *Street Fighter*, Capcom turned it into one of the most memorable – and brutal – scrolling beat-'em-ups. The venerable *Street Fighter II* followed, but *Final Fight* spawned its own series and its characters would feature in future *Street Fighter* games.



### Kirby's Pinball Land

Dropping well-known characters into pinball games has been a hit-and-miss affair. *Sonic Spinball* was second rate, yet Kirby was propelled into one of the best pinball videogames ever. With three brilliant tables, each with boss battles and bonus screens, this was a 'go to' pinball game.



### Super Mario Kart

Of the many Mario spin-offs, none can touch the majesty of *Mario Kart*. The original SNES game effectively created a new genre and numerous imitations followed. To date there are eight main *Mario Kart* games, plus a couple of coin-op titles, and it's surely the greatest spin-off series ever.



### Donkey Kong Country

Mario was obviously the most famous offshoot from the original *Donkey Kong* coin-op, but we can't overlook the incredible *Country* series. Rare created a series of clever, gorgeous platformers for the SNES. The recent updates from Retro Studio have rubberstamped its classic status.

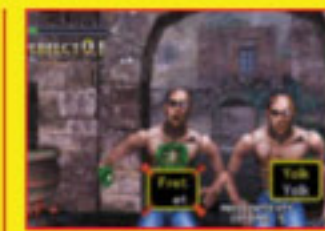

### Typing Of The Dead

Sega threw caution to the wind when it released this delightfully odd spin-off. It was essentially *House Of The Dead 2*, but instead of popping zombies with a lightgun you used a keyboard to Qwerty them to death. Bonkers but oddly fascinating, it has become a favourite at game gatherings.

► [Arcade] The annoying, screen-clogging rainbow bubbles made their debut in *Puzzle Bobble 3*.



of the series. In addition to the PC and Game Boy, the game was ported to the three main home consoles – PlayStation, Saturn and Nintendo 64 – and offered perfect counter-programming to the glut of 3D titles on those systems.

Further games quickly followed and each would merely tweak the winning formula. *Puzzle Bobble 3* (1996) let you bounce bubbles off the ceiling as well as the walls for some trick-shot specials, while *Puzzle Bobble 4* (1997) premiered the contentious chain reaction feature. Chain reactions occurred in versus games when dropped bubbles flew back up and smashed groups of the same colour, causing more bubbles to drop. This looked impressive but messed up the finely balanced gameplay by adding an unwelcome degree of randomness. Thankfully in most of the home conversions you could disable the feature.

The final game to grace the arcades was titled *Super Puzzle*

*Bobble* and it introduced giant bubbles and a new mode where two players could team up together rather than compete against each other. The game was released in 1999, yet outside of the arcade a vast number of home versions have been released since then. In fact, it's hard to think of a platform



that hasn't received a version of the game. And that's just the official releases! If you figure in the countless copies and clones (including mega-popular social/mobile affairs like *Bubble Safari* and *Bubble Witch Saga*) then you can see just how ubiquitous

Taito's little time-waster has become. The Japanese developer may have been guilty of exhausting the basic concept over the years, but its continued popularity shows that it's a true gaming staple with timeless appeal – whatever the name. ★



► [Arcade] In *Super Puzzle Bobble*, two players could tackle puzzles together.

## TERRY FORD

We find out how the Game Boy graphic artist tackled the conversions of *Puzzle Bobble 2* and *3*



**How did you land the job of working on these conversions?**  
I had done regular contract work for Probe Entertainment for several years, mainly working on graphics conversions from arcade games to home consoles and handhelds, so when Probe starting working on the *Puzzle Bobble 2* conversion I was offered the job. I'd worked with the producer and programmer before so I already had a good working relationship with the team.

**What techniques did you use to compensate for the Game Boy's monochrome display?**

We realised right away that we couldn't replicate the bubble colours with just the four greyscale values available on the Game Boy, even with dithering/mixing. Since the player has to identify adjacent bubbles quickly, we decided to add symbols to replace the colours. We basically tried to make each bubble 'colour' as visually distinctive as possible. There was some back-and-forth on the bubble designs, but we settled on a set fairly early in the development of the second game, and used the same ones in the third game.

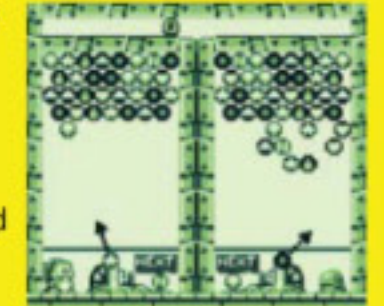

**Did you use the original coin-op version of the game as a source?**

We were provided with the original arcade game artwork, so I was able to derive the Game Boy versions from the original graphics. Because I worked remotely, Probe provided me with a videotaped play-through so I could see how all the animations worked.

**Can you recall how long you worked on the game?**

It was probably two to three months for the graphics conversion. That would be a fairly typical time frame for a conversion to a handheld system. Since we were provided with the original art, the task was mainly a technical one – editing down the number of animation frames and scaling, colour reducing and cleaning up the remaining artwork.

**How pleased were you with the finished games? And are you surprised that the series is still going?**

I was very pleased with the conversions. I think we succeeded in keeping the gameplay and feel of the games intact, despite the inevitable compromises in the graphics. I'm not surprised that the game continues to be released for new platforms. It's a design classic – simple to pick up, addictive and translates well onto low-end hardware, as we proved with the Game Boy versions.

# PUZZLE BOBBLE

## HISTORY

An overview of the Puzzle Bobble games released on coin-op, console and computer



### PUZZLE BOBBLE

AKA: Bust-a-Move YEAR: 1994  
 ■ The classic arcade original that got everything nearly right. The only thing missing was a versus CPU mode to enhance solo play.



### PUZZLE BOBBLE 2

AKA: Bust-a-Move 2, Bust-a-Move Again YEAR: 1995  
 ■ The coin-op sequel let you play against the computer and featured more rounds, special bubbles and varying difficulty levels.



### PUZZLE BOBBLE 4

AKA: Bust-a-Move 4 YEAR: 1997  
 ■ Bubble pullers and the chain reactions were the main additions. The coin-op was ported to several systems including the Dreamcast.



### PUZZLE BOBBLE 3

AKA: Bust-a-Move 3 YEAR: 1996  
 ■ Bubbles were now attached to 'nodes' so you could bounce bubbles off the ceiling. There were now more than 500 rounds.



### PUZZLE BOBBLE 2X

AKA: Bust-a-Move 2X YEAR: 1995  
 ■ A slight upgrade that featured a Christmas-themed intro and new rounds. Some home versions included a level editor.



### PUZZLE BOBBLE MINI

AKA: Bust-a-Move Pocket YEAR: 1999  
 ■ The third game in the series, released on Neo Geo hardware, this time the Pocket Color handheld. Based mainly on Puzzle Bobble 2.



### PUZZLE BOBBLE MILLENNIUM

AKA: Bust-a-Move Millennium YEAR: 2000  
 ■ An exclusive outing for the Game Boy Color. Similar to the GBC version of Puzzle Bobble 4 but featuring an expanded story mode.



### SUPER PUZZLE BOBBLE

AKA: Super Bust-a-Move YEAR: 2000  
 ■ Not a conversion of the earlier arcade game, but a back-to-basics outing for the PC, Game Boy Advance and PlayStation 2.

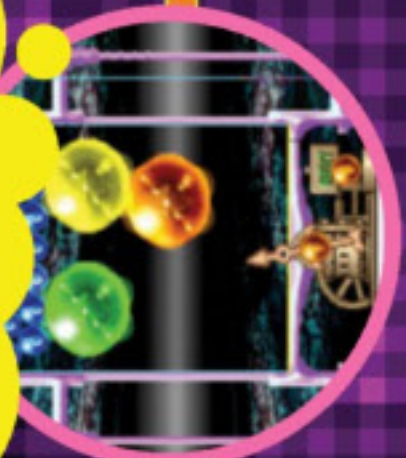

### SUPER PUZZLE BOBBLE

AKA: Super Bust-a-Move YEAR: 1999  
 ■ The fifth and final Puzzle Bobble game to be released in arcades, it tackled on a bunch of extra features with varying success.



### PUZZLE BOBBLE POCKET

AKA: Bust-a-Move Deluxe, Bust-a-Move Ghost YEAR: 2005  
 ■ A version for the PlayStation Portable with lots of modes, many of which were unwanted. Worked well on the handheld's wide display.



### SUPER PUZZLE BOBBLE ALL-STARS

AKA: Super Bust-a-Move All-Stars, Bust-a-Move 3000 YEAR: 2003  
 ■ A version of Super Puzzle Bobble for the GameCube, with the only real addition being a simultaneous four-player mode.



### ULTRA PUZZLE BOBBLE

AKA: Ultra Bust-a-Move YEAR: 2004  
 ■ An update designed specifically for the Xbox with support for online competitive play. The graphics were more garish than ever!



### SUPER PUZZLE BOBBLE 2

AKA: Super Bust-a-Move 2 YEAR: 2002  
 ■ A second title for the PlayStation 2 that was very similar to the first. Chain reactions returned and a level designer was added.



### PUZZLE BOBBLE DS

AKA: N/A YEAR: 2005  
 ■ The first Puzzle Bobble game released for the Nintendo DS, but only in Japan. Both screens were cleverly utilised in versus mode.



### HIPPATTEI PUZZLE BOBBLE

AKA: Bust-a-Move DS YEAR: 2005  
 ■ The second DS game was released internationally. This time you used the stylus to pull back a slingshot and fling bubbles into play.

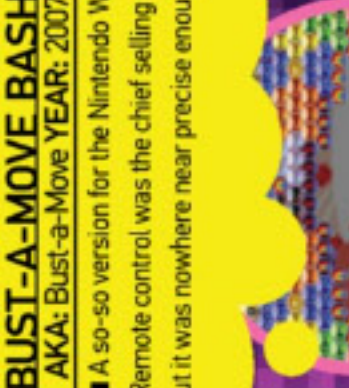

### BUST-A-MOVE BASH!

AKA: Bust-a-Move YEAR: 2007  
 ■ A so-so version for the Nintendo Wii. Wii Remote control was the chief selling point, but it was nowhere near precise enough.

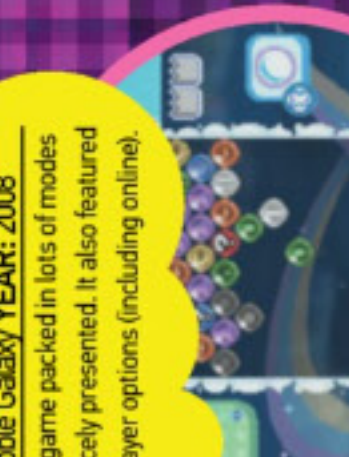

### SPACE PUZZLE BOBBLE

AKA: Space Bust-a-Move, Puzzle Bobble Galaxy YEAR: 2008  
 ■ The third DS game packed in lots of modes and was very nicely presented. It also featured various multiplayer options (including online).



### PUZZLE BOBBLE UNIVERSE

AKA: Bust-a-Move Universe, Puzzle Bobble 3D YEAR: 2011  
 ■ Inevitable release for the Nintendo 3DS. A middling title that made little use of the 3D display and lacked multiplayer modes.



### PUZZLE BOBBLE LIVE!

AKA: Bust-a-Move Live! YEAR: 2009  
 ■ A streamlined entry for the Xbox 360, released as an Xbox Arcade title. Online competitive play was included, hence the title.



### PUZZLE BOBBLE PLUS!

AKA: Bust-a-Move Plus! YEAR: 2009  
 ■ The second Wii entry was released as a WiiWare title. It was missing some modes and features – and was arguably better for it.

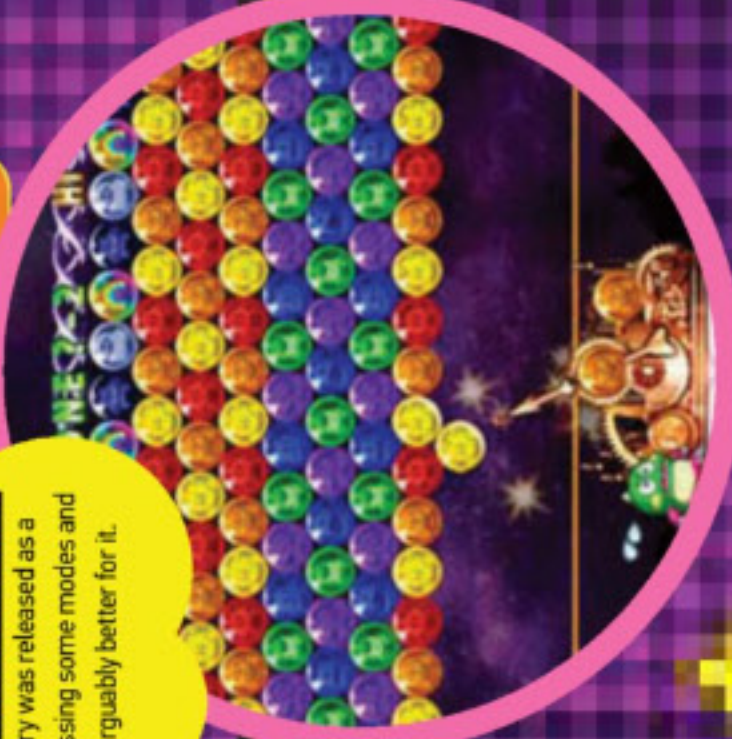

THE NEXT



# IMPORT ONLY

## COOL COOL TOON

**GAME ORIGIN**



- » COUNTRY: JAPAN
- » POPULATION: 127 MILLION
- » CAPITAL: TOKYO
- » NATIONAL LANGUAGE: JAPANESE
- » CURRENCY: YEN
- » TIME ZONE: UTC+9

» CO-ORDINATES: 36°00'00" N 128°00'00" E



» [Dreamcast] Cut-scenes advance the story and show off the various character costumes on offer.

In fact, everything seems to come to life, with background characters bouncing around and ensuring that there's never a dull moment. The simplistic appearance also has some technical benefits – the lack of shading allows the game to maintain an excellent frame rate.

But good looks only carry a game so far and eventually you'll have to dance. During gameplay, the middle of the screen is dominated by a circle in which commands are displayed. The A button symbol appears in the centre, with a white outline closing in on it – when the outline meets the edge of the symbol, you need to press the button. When button symbols appear off-centre, you'll need to move the analogue stick to match the symbol's position as well as hitting the button. Occasionally, multiple non-button symbols appear on the outside, with a wave advancing towards them; for these, just move the stick in the direction indicated. It sounds simple, but the game soon becomes complex. That command circle gets busy, particularly when rapid presses and various buttons are involved. It's a good system, but the difficulty ramps up very quickly.

Fortunately, the other key ingredient of a rhythm-action game is present – the music. As you'd expect from a Japanese music game, the musical genres used centre on

» [Dreamcast] Cool Cool Toon's art style even manages to inject colour into graveyard areas.



J-pop, with some dips into rock and hip-hop territory. While it's all technically well produced, some of the tunes can be a tad twee, something which seems to come with the cartoon theme. However, this doesn't diminish the impact of the better music and some of the tunes are genuinely among the best we've heard – Irony in particular is a favourite track, which we'd recommend as an underappreciated gem.

While the game isn't tremendously long, there's a lot to do. For a start, Amp and Spica encounter different characters during their stories, resulting in different music for each and revealing the game's use of leitmotif. You can also buy a variety of outfits for Amp and Spica and unlock the various opponents you encounter during the game, for use in the game's single-track modes – which can be played alone, competitively or co-operatively. The game even allowed for further costumes to be bought online with in-game currency, though the service has long since been discontinued.

For the hardcore, there's even more. The game uses the rare and underutilised Neo Geo Pocket Color link cable to hook up to *Cool Cool Jam*, a Japan-only release for SNK's handheld, allowing you to exchange the game's currency between the two platforms. *Cool Cool Toon* includes all kinds of wallpaper



» [Dreamcast] Early stages use just the A button, but by Episode 3 the others are added.

» [Dreamcast] Replays enable you to watch the dancing animations without button prompts.



» [Dreamcast] Weird creatures are commonplace in *Cool Cool Toon* – this gigantic yellow dog used to be a human.

“ Visual designer Ippei Gyoubu's vision is done justice, with the flat-coloured characters granted the excellent animation they need to really bring their dance routines to life ”

### CAN'T IMPORT? YOU COULD TRY



#### SPACE CHANNEL 5

» The Morolians are invading and forcing human hostages to dance, so it's up to news reporter Ulala to fight them off. Along the way you'll encounter bizarre bosses, rival reporter Pudding and even Michael Jackson. The title employs PaRappa-style listen-and-repeat gameplay. Both the Dreamcast and PlayStation 2 versions can be picked up cheaply.

images and character art for users who insert the disc into their PC's drive, as was common for Dreamcast releases, but went one step further with a text file that explained how to use *Samba De Amigo's* maracas to play the game. Clearly, SNK went all-out with the unconventional thinking here.

For fans of music games, this one is well worth tracking down. There's very little out there that's like it, and there was no sequel. *Cool Cool Toon* was released after SNK had largely withdrawn from non-Japanese markets and was in a downward spiral towards bankruptcy. That precluded any possibility of a Western release and while the game has occasionally been referenced by SNK Playmore in crossover titles such as *Neo Geo Battle Coliseum*, it looks unlikely that the company will ever rerelease it for modern platforms.

But, as always, there's a twist in the tale – and in true SNK fashion, it's ever so slightly conservative. The recent mobile game *The Rhythm Of Fighters* basically lifts *Cool Cool Toon's* game mechanics wholesale, but places them in a *King Of Fighters* theme. While there are a few new touch-screen mechanics, the game is remarkably close to the Dreamcast game of 2000. SNK is dead, long live SNK Playmore. *Cool Cool Toon* is dead, long live *The Rhythm Of Fighters*. ★

## GO DEEPER

Strictly cool dancing

- BOON TOWN RATS**
  - » Once you've strung together a good combo, you'll be awarded a Boon Chance – activate it with L or R and you'll gain a score multiplier. Subsequent Boons award more points.
- HIDDEN CHARMS**
  - » The characters are often hidden behind the button prompts, and the action is constant enough that the dance routines are mainly for the benefit of spectators.
- A PERFECT CIRCLE**
  - » You need to wait until the moment the outline for the button symbol is off to actually press the button. The next press is always highlighted with a white outline for clarity.
- WALK THE LINE**
  - » The status bar shows how you're doing, with nine performance levels possible. The vertical line shows the passing mark – here, you'll need to be at Level 4 to pass.

### INFO



- » PUBLISHER: SNK
- » DEVELOPER: SNK
- » SYSTEM: DREAMCAST
- » ALSO ON: N/A
- » GENRE: RHYTHM-ACTION
- » RELEASED: 2000
- » EXPECT TO PAY: £15-20

### EVOLUTION OF THE GENRE

#### ▲ Retro

**PARAPPA THE RAPPER**  
RELEASED: 1996  
Rodney Greenblatt's paper-thin, hip-hop-loving dog introduced many a gamer to the rhythm-action genre. The action came in the form of a relatively easy *Simon*-esque game of repetition, but the game was elevated to million-selling hit status by its colourful character designs and memorable songs.

#### ▼ Modern

**HATSUNE MIKU: PROJECT DIVA F**  
RELEASED: 2012  
This game doesn't tie songs together with any story. It doesn't have to – Hatsune Miku, the character created to promote Vocaloid singing voice synthesizer software, has achieved worldwide popularity. Not only has her game received a Western release, she's opened for Lady Gaga. Really.





## AMIGA 1200

The third-generation A1200 was the 'super-Amiga' for the masses, equipped with an upgraded CPU and superior visual capabilities compared to its older cousins. Mike Bevan looks at some of games that tapped into its potential

# SUPER STARDUST

DEVELOPER: BLOODHOUSE ■ YEAR: 1994

■ The original *Stardust* was one of the most overlooked shoot-'em-ups on the Amiga, a fiendish update of *Asteroids* with stunning ray-traced graphics, a thumping techno soundtrack and a steep difficulty curve. Coded by Harri Tikkanen, at Finnish developer Bloodhouse, it did things you just didn't expect a stock Amiga to do, particularly in its hyperspace-tunnel sequences, which evoked *Space Harrier* and the old Sega *Buck Rogers* coin-op, but looked a hundred times better.

Designed to take advantage of the Amiga 1200's improved AGA chipset, this sequel is basically *Stardust* with everything cranked up to 11. The game was released on six floppy disks, twice as many as the original, which was an indication of the amount of visual data packed into the title. And unlike *Asteroids* there was actually a plot... sort of. The evil Professor Schaumund, freshly defeated in *Stardust*, has returned with a new army, this time equipped with enough firepower to

“Even today the tunnel sections look stunning, with incredibly smooth graphics”

blow up whole star systems. He's also gone and kidnapped the hapless princess Voi Levi. Again. Luckily for you, you've been given a brand new, supercharged multi-weapon-system fighter with intergalactic hyperspace motors and optional air conditioning. It's down to you, and you alone, to sort out this mess and restore peace and tranquillity to the universe. Oh, and did we mention that the Prof is actually a little blue penguin in a top hat? Welcome to *Super Stardust*...

The first thing *Stardust* players will notice is that the cute Fifties-style cartoon rocket-ship has been replaced by a sleek raptor-like craft. The game's difficulty has also been

knocked down a notch compared to the original, but you'll still need to be a decent pilot because *Super Stardust* is definitely no slouch at killing you. The asteroids come in three different varieties: an easily destructible grey type, the slightly tougher purple kind, and extremely hard gold rocks that require serious weaponry to sort out. There are five stages, linked by visually upgraded tunnel sections packed with obstacles and inhabited by an imposing and very mobile guardian. Even today these look stunning, with incredibly smooth graphics that put contemporary titles like the CD-based *Microcosm* to shame. As you make

your way through the half-dozen screens making up each level you'll also encounter additional enemies, from fire-spitting UFOs and Predator-like cloaking spaceships to cosmic starfish and snake-armed bosses. Luckily, *Super Stardust* provides you with plenty of tools to deal with the staggering amount of interstellar shrapnel it shifts about. Destroying weapon-carrying enemies grants you new toys to play with, from bouncing bullets to flamethrowers and missiles, and there's a *Gradius*-like power up system where you can route upgrades to various bits of kit via an in-game menu. Conserving your weapon power is the key to success in the game, since repeated dying depletes your combat-effectiveness drastically. So stay alive soldier, and go bust some space-rocks in glorious Amiga-vision for us, there's a good chap. And mind that penguin.

## IN DEPTH



■ [Amiga 1200] Eat flamethrower, snakey-boss thing



■ [Amiga 1200] The first of the awesome 3D hyperspace corridor sequences

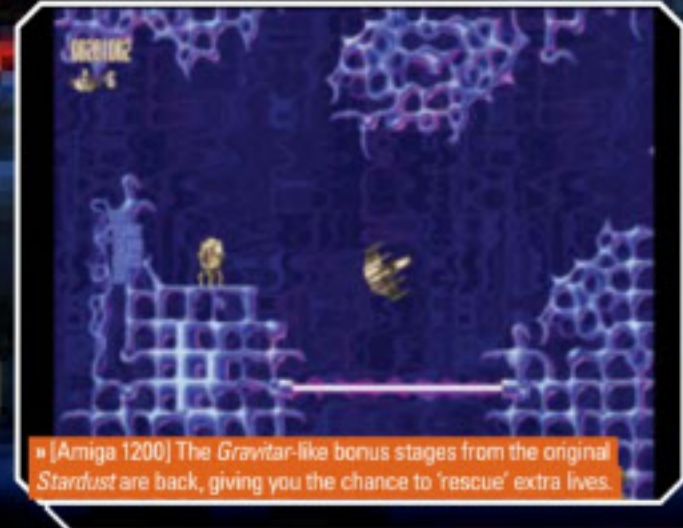

■ [Amiga 1200] The Gravitar-like bonus stages from the original Stardust are back, giving you the chance to 'rescue' extra lives



### IT'S TIME TO TAKE TO THE STARS

■ This is your X-wing like ship. Holding the joystick down activates a handy shield, so use it often and wisely.

### SHOOT THE CORE. LIKE A BOSS!

■ Mini-bosses like this missile-firing Predator appear throughout the game. Take them out quickly!

### POWER-UP!

■ This useful power-up icon increases your weapon's firing speed. The other power-up (bottom right, next to a rock) activates a mini smart-bomb.

### THE RACE AGAINST TIME

■ Falling to clear a screen before this timer runs out results in being swarmed by lots of annoying little ships.

## IF YOU LIKE THIS TRY...



### MEGA APOCALYPSE

C64  
■ *Mega Apocalypse* was the follow-up to the popular shooter *Crazy Comets*, which was in turn based on the underrated Gottlieb coin-op *Mad Planets*. It's a suitably manic effort, improving on the graphics of the original and giving us bigger, meaner and distinctly more dangerous astronomical bodies to blast. Plus simultaneous two player co-op and an epic Rob Hubbard remix of the first game's already excellent soundtrack.

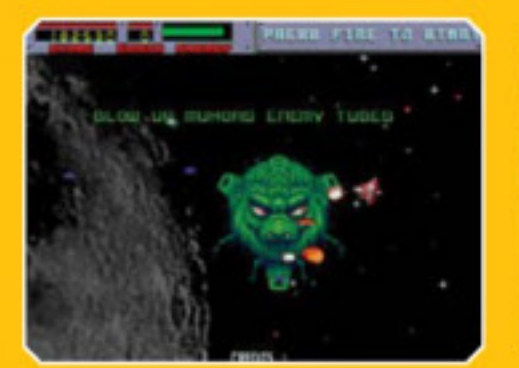

### BLASTEROIDS

ARCADE, VARIOUS  
■ The final arcade outing for Atari's famous *Asteroids* brand, *Blasteroids* was designed by *Battlezone* coder Ed Rotberg, and its level selection mechanic, allowing players to complete stages in any order, pre-empts the one seen later in *Stardust*. One nifty aspect is the co-op mode, which allows two players to join their ships into one with even greater firepower. But watch out for Mukor, the game's Sinistar-like boss...



### SUPER STARDUST HD

PLAYSTATION 3  
■ Released as a download for PS3 in 2007, and designed by original coder Harri Tikkanen, this second sequel brought the series up to date in spectacular style. It differs from previous instalments in using a *Time Pilot*-style control scheme, with a massive planet that rotates below the player's ship as you battle waves of giant multicoloured asteroids, enemy spacecraft and, of course, the occasional space penguin.

In a distant galaxy, a long, long time ago...

■ [Amiga 1200] ...lived a galactic princess named after a brand of Finnish margarine...



■ [Amiga 1200] It's Asteroids Jim, but not as we know it...

## ONESCAPEE

DEVELOPER: SADENESS SOFTWARE ■ YEAR: 1997

With its gorgeous hand-drawn backgrounds and wonderfully fluid character animation, this CD-ROM based title is certainly one of the most visually impressive of all Amiga games. Released towards the end of the machine's commercial life, it's an arcade-adventure with obvious similarities to pioneering titles *Another World* and *Flashback*. The story follows the consequences of the alien-abduction of the game's protagonist, Daniel White, and his attempts to escape a strange planet on which he finds himself after his kidnappers' ship crash-lands. Starting in a curious garbage-dumping ground, you'll progress through caves, waterfalls and futuristic cities in your quest to find sanctuary. Presentation is top-notch, with an epic opening sequence and fully animated cut-scenes spicing up the puzzle-oriented gameplay, and lots of gruesome and sometimes amusing death-scenes. Luckily, the game allows you to save at any time, and Daniel can later equip a gun to blast the worryingly numerous droids and alien wildlife. *OnEscapee* is probably a game best played with a walkthrough at your fingertips as many of the puzzle solutions can be a bit on the illogical side. If you make it to the finale of the game, you'll be rewarded by a sequence that wraps up the experience in an unexpectedly emotional twist ending.

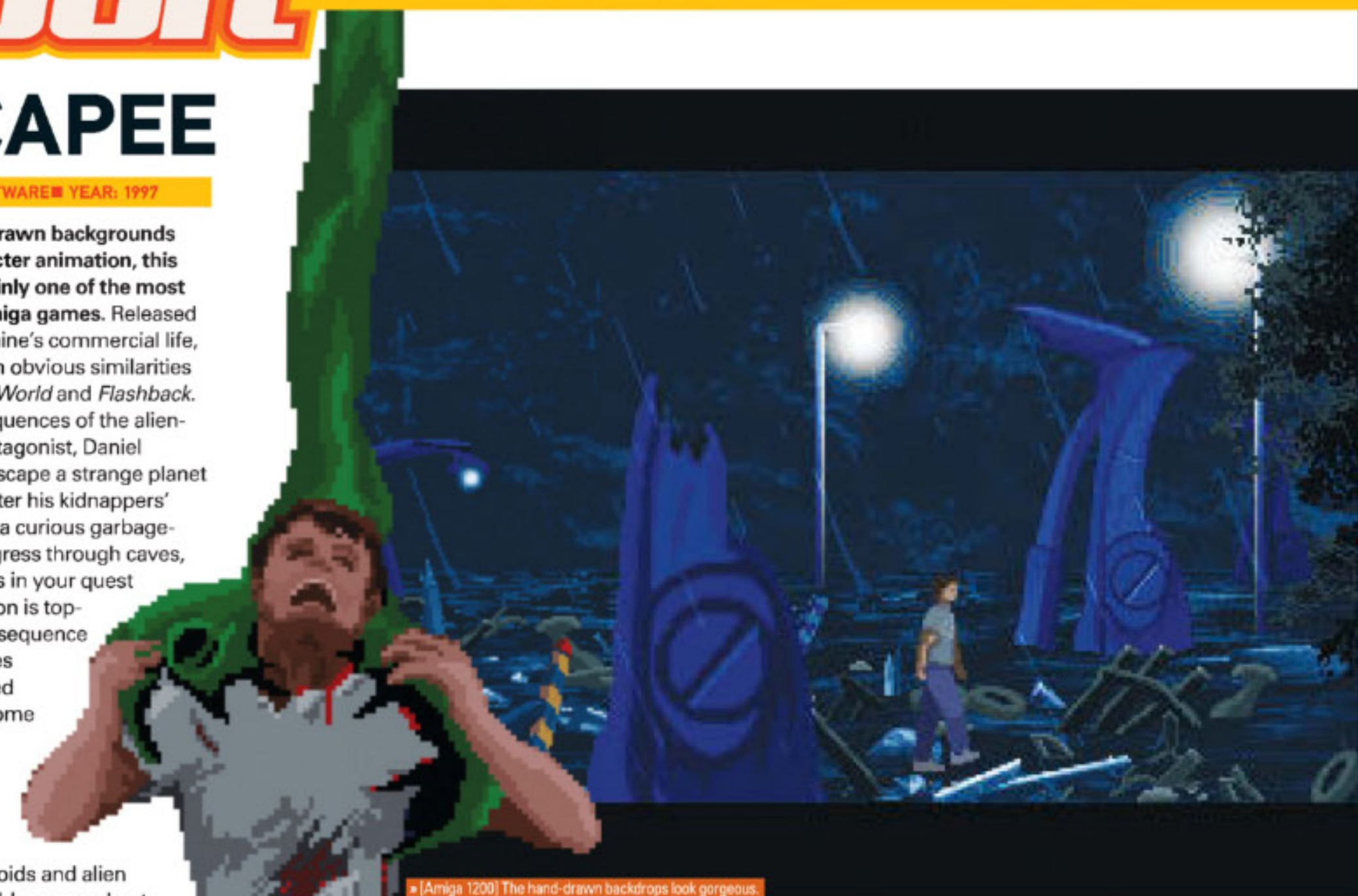

[Amiga 1200] The hand-drawn backdrops look gorgeous.

“Presentation is top-notch, with an epic opening sequence and fully animated cut-scenes”

## BANSHEE

DEVELOPER: CORE DESIGN ■ YEAR: 1994

Probably the best vertically scrolling A1200 shoot-'em-up ever. We're not sure what it is about Scandinavian developers that makes for top-quality Amiga blasters, but this was another courtesy of Søren Hannibal and Jacob Andersen. Rising from the Danish demo-coding scene, the pair took inspiration from the classic Capcom coin-op *1942*, mixed in a dash of *SWIV* and *Battle Squadron*, and added a twist of *Chaos Engine* steampunk to create a terrific-looking shooter. *Banshee* is a huge game, with vast scrolling levels brimming with heavily armed battleships, submarines, prop-driven bombers and the odd Eskimo. The attention to graphic detail in *Banshee* is incredible, with scores of carefully animated *Cannon Fodder*-style infantry milling about in the background, civilians running for cover, and clever weather effects all adding to the atmosphere.



[Amiga 1200] These twin Flying Fortresses are early sub-bosses in the game.



[Amiga 1200] I spy, with my little eye, something beginning with T.

Impressive sprite effects include a boss with swinging arms and a giant crane equipped with a wrecking ball. And naturally, there are plenty of weapon pick-ups to maximise the carnage, resulting in a deluge of on-screen firepower, especially if you've got a friend to join in the simultaneous two-player mode. An essential title for Amiga 1200-owning shoot-'em-up fans.

**RETRO STINKER**  
» DANGEROUS STREETS  
DEVELOPER: FLARE ■ YEAR: 1993  
One of the worst fighting games ever, *Dangerous Streets* was awarded 3% by Stuart Campbell in *Amiga Power*. Awful controls, crummy characters and woeful animation make it even worse than *Rise Of The Robots*.

## MORE GAMES TO PLAY

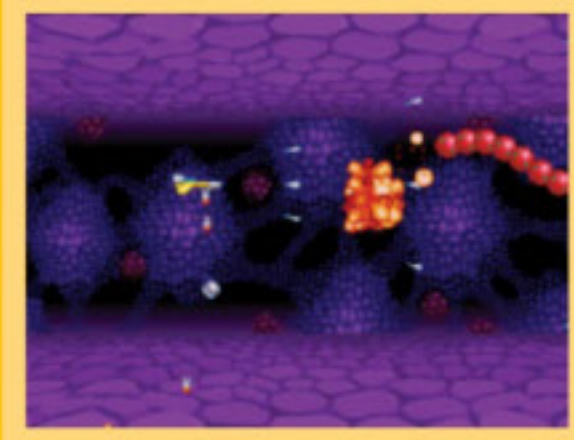

» **OVERKILL**  
DEVELOPER: VISION SOFTWARE ■ YEAR: 1993  
*Overkill* is a reimagining of the coin-op *Strike Force*, a semi-sequel to the classic *Defender*. It's a fast-paced and very entertaining shooter that sees you travelling through an alien solar system defending little men and blasting bug-eyed critters which are trying to steal valuable crystals. The graphics are simple but effective – particularly the explosions, which shower extraterrestrial goo all over the screen in a most satisfying manner.



» **OUT TO LUNCH**  
DEVELOPER: MINDSCAPE ■ YEAR: 1994  
Starring the cute Pierre Le Chef, *Out To Lunch* is a great little platform game in the vein of *Bubble Bobble* and *Rainbow Islands*. Like most TV chefs, Pierre is off around the world cooking things, which mostly involves chasing his ingredients around the screen, stuffing them in a big bag and delivering them to a cage somewhere on each level. Unfortunately, his quest is fraught with culinary peril, in the shape of his nemesis Chef Noir...



» **EXILE**  
DEVELOPER: AUDIOGENIC ■ YEAR: 1995  
Starting life on the BBC Micro, *Exile* was collaboration between programmer Peter Irvin and Jeremy Smith, the author of *Thrust*. Taking place in a vast cave system beneath a mysterious planet, it features a remarkably lifelike physics engine, which is put to good use as its jetpack-wearing hero explores his surroundings. The A1200 version completely updated the graphics, which look beautiful.



» **GLOOM**  
DEVELOPER: BLACK MAGIC ■ YEAR: 1995  
Coding genius Mark Sibly (of *Overkill* and *Blitz Basic* fame) was responsible for this attempt at a *Doom*-style FPS. And he pretty much nailed it while simultaneously lampooning and paying homage to id's famous PC title. Shamelessly ripping a load of sound effects from the movie *Aliens*, it was surprisingly nippy on a standard A1200 if you fiddled with the screen settings, and even better with extra memory.

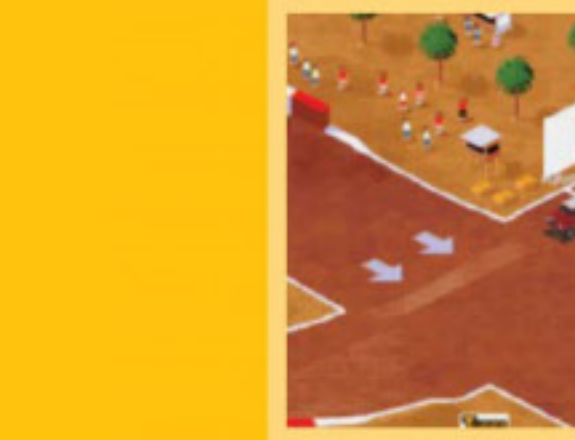

» **SUPER SKIDMARKS**  
DEVELOPER: ACID SOFTWARE ■ YEAR: 1995  
While hardly the most original title, this top-down racing game is remarkably enjoyable with a few mates, all bombing round a huge selection of tracks in Minis, dune buggies or even cows! There's even an option to link two A1200s together and play a simultaneous eight-player mode using two monitors placed side by side, which is surely one of the most ambitious multiplayer modes created for any Amiga game.



» **VIROGOP**  
DEVELOPER: GRAFTGOLD ■ YEAR: 1995  
The final Amiga title from Andrew Braybrook's Graftgold studio, *Virocop* could be described as a hybrid of *Paradroid* and *The Chaos Engine*. Starring a little yellow robot named D.A.V.E., it sees you clearing a number of imaginative videogame-themed levels of nasty viruses with assorted weapons. Although released for other Amigas, this version features better graphics and sound and an exclusive medieval level, 'Crusader'.

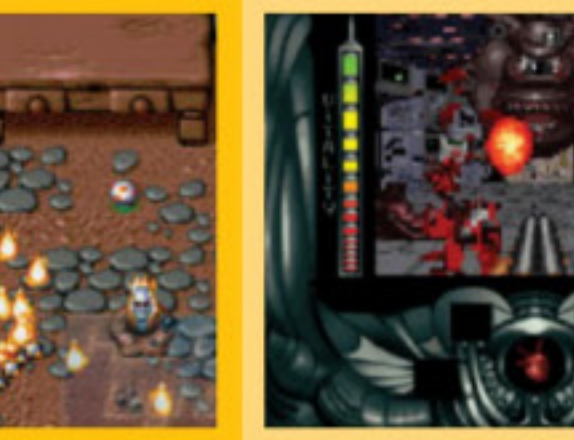

» **ALIEN BREED 3D**  
DEVELOPER: TEAM 17 ■ YEAR: 1995  
This 3D update of Team 17's popular franchise was designed to cash in on the mid-Nineties craze for all things *Doom*-like. Despite the blocky texture-work it's surprisingly atmospheric, with plenty of nasty xenomorphs to blast or run away from. The game engine is an improvement on *Gloom* in including proper elevation and staircases, but isn't as fast and really requires an accelerator card to get the best out of.



» **LEGENDS**  
DEVELOPER: KRISALIS ■ YEAR: 1996  
Along with Team 17's *Speris Legacy*, this was one of the few successful attempts to produce a *Zelda*-like action-RPG for the Amiga – and we prefer *Legends* out of the two. With a time-travelling plot set across four worlds, North America, China, Egypt and Medieval England, it's down to you to save each civilisation from a mysterious alien conspiracy. The main downside is the lack of a proper in-game save system.

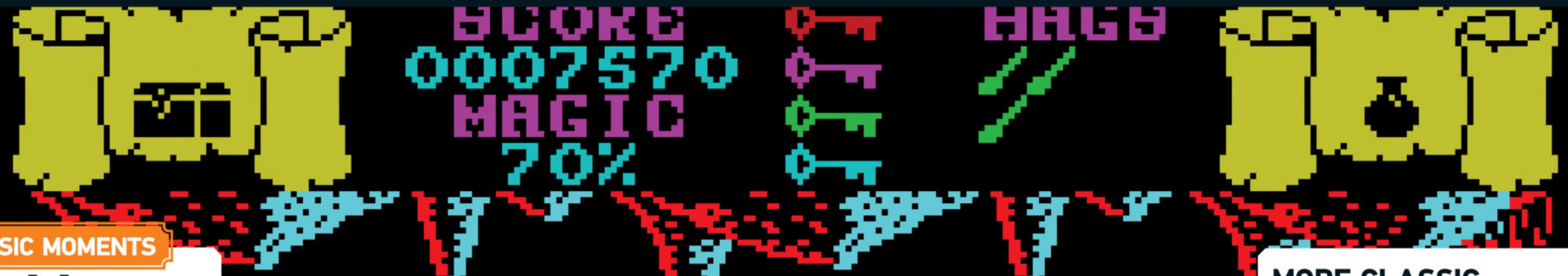

CLASSIC MOMENTS

# Cauldron

PLATFORM: ZX SPECTRUM • DEVELOPER: THE RAMJAM CORPORATION  
 RELEASED: 1985

The real reward of a quest isn't found in reaching your goal – you'll gain far more of worth from the hardships you overcome to get there. Well, that's what we're told sometimes, but we're not so sure. There's a certain pleasure to be found in a sure thing, when success is already assured and all that remains is for you to claim your prize. That's definitely the case with *Cauldron*, which is not an easy game by any stretch of the imagination.

Once you've collected all six potion ingredients and have the ability to win the game, it's time to make your way to the green door. The Hag appears in what seems like any other cavern of the underworld and you prepare yourself for an arduous trial, but the pumpkin enemy merely bounces away, leading you towards two larger pumpkins – and the golden broomstick. With the potion brewed, you can treat the pumpkins like any other enemy, smashing through them as you complete the game and take your rightful place as the Witch Queen. ✨

## BIO

Released by Palace Software in 1985, *Cauldron* was an innovative game for the 8-bit micros which cast players as a witch seeking to brew a potion to defeat the pumpkin and become Witch Queen. Combining shoot-'em-up and platform gameplay for a well-rounded arcade adventure, it received critical acclaim, scoring 87% in *Zzap!* and 91% in *Crash* as well as earning praise from a variety of other magazines. However, the pumpkin didn't take defeat lying down and came back with a vengeance in the totally different 1986 sequel *Cauldron II: The Pumpkin Strikes Back*.

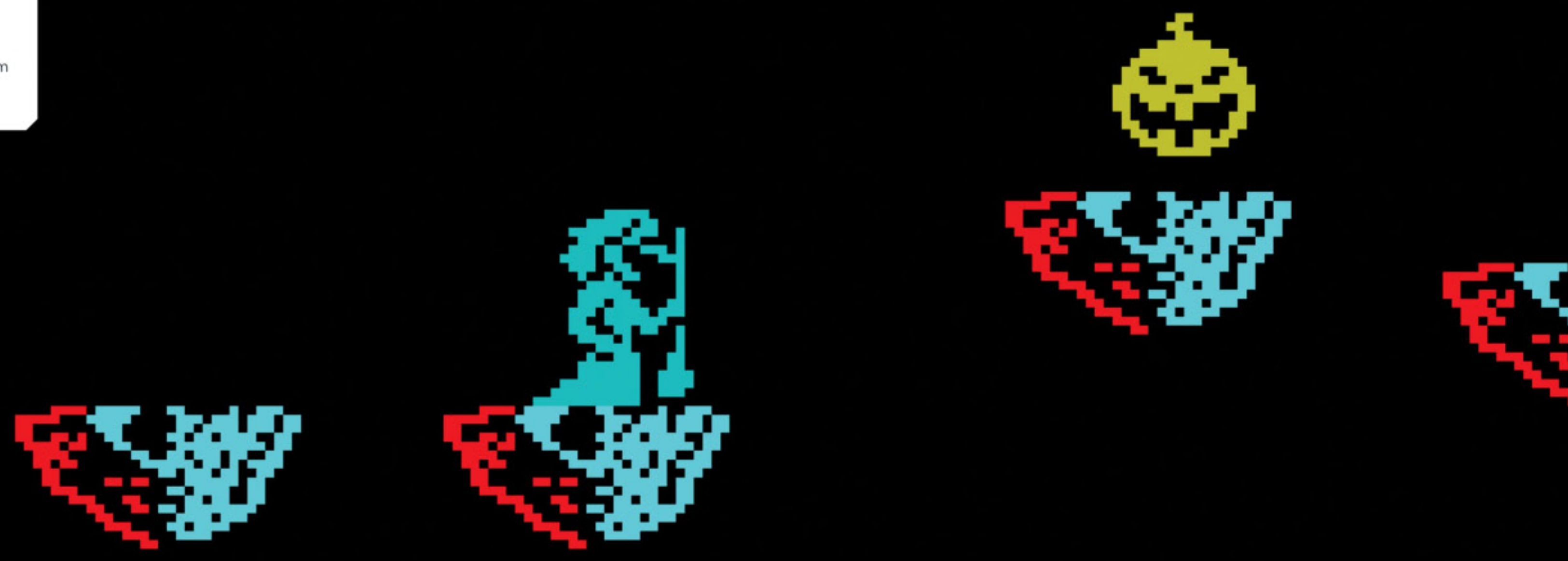

## MORE CLASSIC CAULDRON MOMENTS

### Air raid

The Hag is a tooled-up merchant of magical death while flying around, capable of removing the plentiful enemies with a single shot. But when she lands to pick up a key, she's totally defenceless and the airborne enemies don't go away. You'll be anxiously willing her to move faster as she shuffles steadily towards her goal, her health plummeting.



### Spirit of Columbus

Although it's hard to take it in as you're under constant attack, *Cauldron's* world is really quite impressive. As you fly through searching for the coloured doorways, you'll see that it's divided into a number of distinct regions. These include a forest, a cemetery, an ocean and a volcanic mountain range, each of which is visually distinct and many screens wide.



### Dangerous depths

Venturing into the caverns of the underworld for the first time is a daunting experience. The Hag is as defenceless walking around below ground as she is on the surface, and enemies are just as plentiful as before. The areas are big, too – you'll be hard-pressed to complete the journey through them, especially as the platform edges are so dangerous.

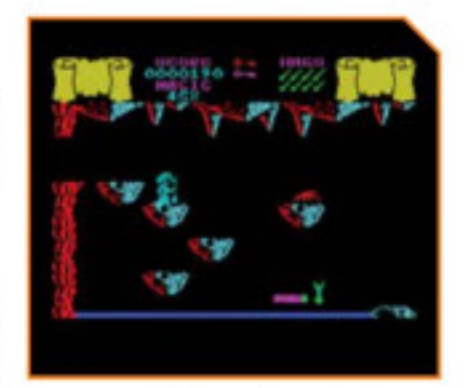

### Give peace a chance

There's an interesting mechanic at work in *Cauldron* – that Magic percentage in your heads-up display represents both your life and your ammunition. It's quite generous, as colliding with an enemy only drops it by around 5%, while each shot costs 1%. However, this means that the unspoken third option of simply avoiding enemies is usually the best choice, if possible.



GOING WEST

LOST IN TRANSLATION

# LOST IN TRANSLATION

It's often true that we see things differently to folks overseas, but in videogames that's rather more literally true. Join Nick Thorpe for a look at how localisation has shaped our views of gaming classics...

Picture the scene: it's a late night in Assmannshausen, Germany. We're sitting in a hotel room, with a dubbed version of the *Mortal Kombat* movie on the TV to provide background noise as we read about the 32X. We're rather dedicated to the retro cause, after all. Suddenly, the adverts kick in and we see something that teaches us a very important lesson about attitudinal differences between the UK and Germany – specifically, that Germany seems to be far more tolerant of nudity in advertising. It's only a minor incident of culture shock, but one which serves to highlight a difference in cultural sensibilities.

The growth of the videogames industry from a collection of regionally distinct markets into a relatively cohesive global market has presented developers with challenges. Developers haven't just had to translate their games for international audiences – often they have been required to adjust the content of their titles too, to prevent the kind of surprise mentioned above. This can take place for all kinds of reasons – there may

be additional legal requirements or cultural differences to take into account, or licensing problems may come into play over issues such as character usage and console manufacturers' content guidelines. Sometimes, the developers do it of their own accord, based on their beliefs about the market they're selling to.

The most notorious cause of changes in localisation is easily the requirement for censorship. Sex, violence and religious symbolism are all common triggers, and each territory handles things differently in this regard. Similarly infamous are those games which adopt a different skin for their releases in other regions based on the publisher's perception of what will sell well – the most famous of these is *Super Mario Bros 2*, which we'll cover later. Additionally, it used to be quite common to tweak difficulty levels, with releases often made harder outside of Japan in order to prevent the rental market from damaging sales.

Although these changes might sound broadly negative, they can often prove beneficial. While players might see them as an unwelcome deviation from the original intent of the developer, developers often implement bug fixes in localised

versions of their games. Occasionally, they even introduce additional content – for example, Sega attempted to boost the Western appeal of *Jet Set Radio* by adding extra American-themed stages and music to the game for its international debut. Other additions, such as the extra bosses present in international versions of *Final Fantasy VII*, have a less specific purpose than Sega's example but are no less welcome.

Trends in localisation have changed considerably over the years. In the Eighties and Nineties, it wasn't uncommon to see games heavily revised from their original forms, and this was often seen as being a desirable thing to do (by publishers, at least – consumers were generally none the wiser). However, this approach began to lose support in the mid-Nineties due to a variety of factors, including the increasing international popularity of Japanese media and particularly the spread of the internet. Players today are often better informed about what is launching elsewhere in the world, and news of any changes to content will spread extremely quickly. As a result, cuts and alterations need to be handled with care to avoid being frowned upon by fans who may simply choose to import.

As the preference for generally unaltered releases has grown, so too has the professionalism of the localisation business. In the Eighties and even well into the Nineties, Japanese developers would often write the

English dialogue for their games in-house and seemingly without the aid of native speakers. The results of such translation have become notorious, with the likes of *Zero Wing*'s "all your base are belong to us" gaining iconic status. Today, you're much more likely to see the work of localisation professionals – and even if they only work with dialogue, it's now increasingly common to see translations which attempt to convey the original spirit behind the words. Wordplay jokes and local cultural references often lose their impact when translated directly, and are now typically replaced in localisation.

Localisation is one of the most overlooked parts of game development, but a hugely important one which will continue to have an effect on videogames for as long as the medium lasts. Since the practice began, localisation edits have affected a wide range of titles, both influential and obscure, and we've selected a number of examples to illustrate that point. These games highlight some of the most common reasons for changes – you might be surprised to learn about some of the more unusual aspects of your favourite releases...



## THE SPECIALISTS

Some of the notable publishers that have made localisation their key business

### WORKING DESIGNS

Victor Ireland's company rose to prominence as a localisation team that specialised in Japanese RPGs, initially as a supporter of the TurboGrafx-16 before moving on to the Saturn and PlayStation.

### NOTABLE RELEASES

- Lunar: Silver Star
- Alundra
- Silhouette Mirage

### ATLUS

Early Atlus localisation efforts such as *Revelations: Persona* were poor, but the company has since delivered strong localisations of its own games as well as those from external developers.

### NOTABLE RELEASES

- Revelations: Persona
- Disgaea: Hour Of Darkness
- Rule Of Rose

### NIS AMERICA

Nippon Ichi Software has branched out into Western publishing and localisation over the last decade, and has become one of the most notable localisation companies in business today.

### NOTABLE RELEASES

- Atelier Iris: Eternal Mana
- Sakura Wars: So Long My Love
- What Did I Do To Deserve This, My Lord?

### NEC TECHNOLOGIES

Established to bring Japanese PC Engine titles to the TurboGrafx-16, NEC Technologies didn't survive as a publisher due to the North American failure of the system it was intended to support.

### NOTABLE RELEASES

- Ys: Book I & II
- Ys III: Wanderers From Ys
- JJ & Jeff

### INTERNATIONAL

[NES] *Super Mario Bros 2* is the version that most players are now familiar with.

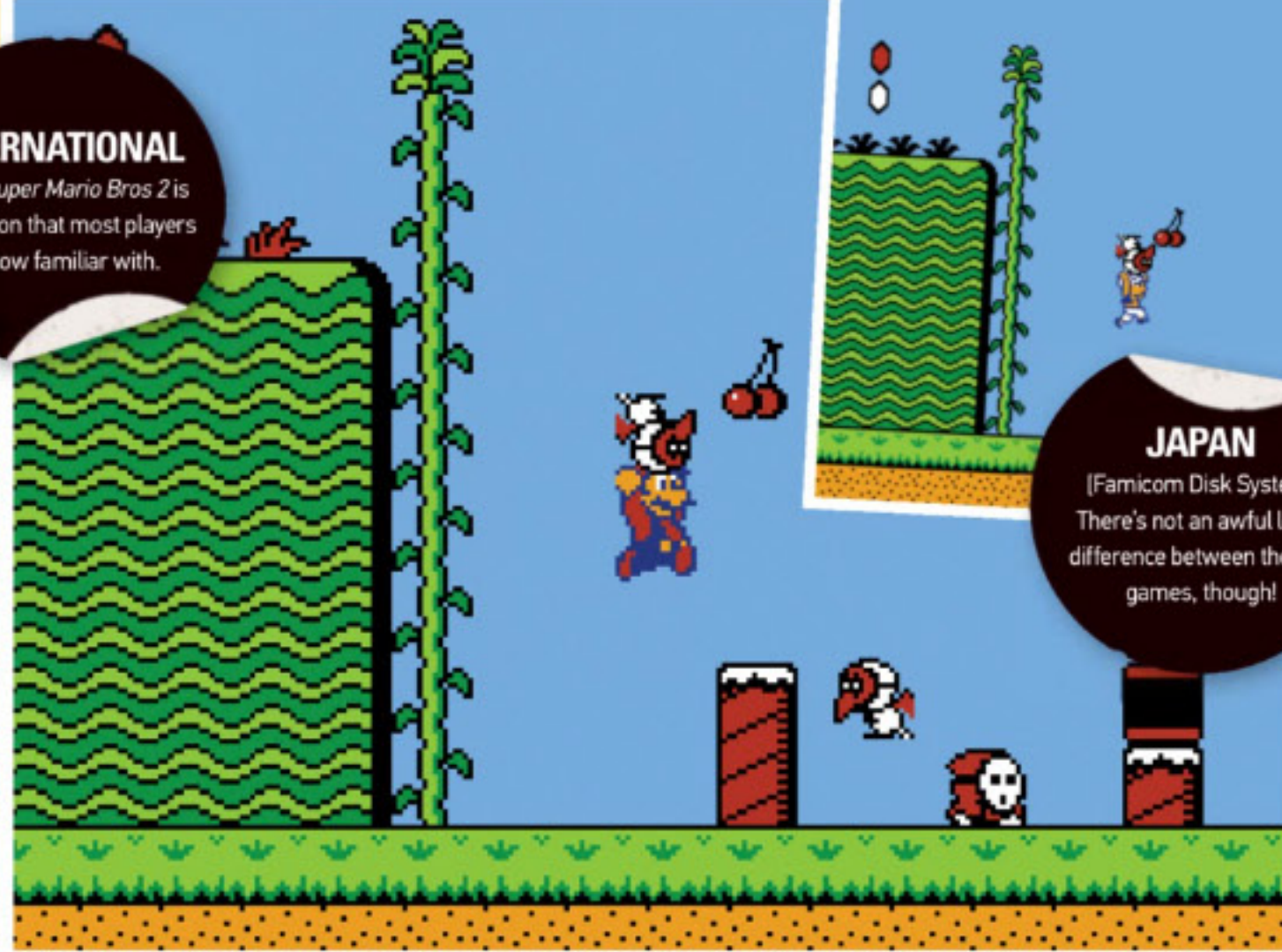

### JAPAN

[Famicom Disk System] There's not an awful lot of difference between the two games, though!

## SUPER MARIO BROS 2

### NINTENDO 1988

The middle child of the NES Mario trilogy is one of gaming's most famous localisation stories, in part because it was one of the first to be widely told. The Japanese game known as *Super Mario Bros 2* was not tremendously different from the original game – it featured some minor graphical upgrades and a few new items such as the harmful poison mushrooms, but to the untrained eye it might as well be the original. The major difference was in its difficulty, as the game was significantly harder than its predecessor.

Nintendo Of America wasn't taken with the game, to say the least. The view there was that the game wasn't accessible enough, and that it would be outdated by the time of release. However, a *Super Mario Bros* sequel was still an absolutely crucial part of the NES line-up. The solution was to take an unrelated Famicom Disk System platform game called *Yume Kojin: Doki Doki Panic* and transform it into a Mario game.

The changes made to create *Super Mario Bros 2* were actually relatively minor, largely involving the replacement of the original Fuji TV characters with the Mario cast – long-standing Mario cast members such as Birdo, Bob-Ombs and Shy Guys were all present in the original release anyway. Some minor gameplay alterations were also made, such as the addition of a run button and the replacement of a second Mouser encounter with the new enemy Clawgrip.

*Super Mario Bros 2* is an unusual case in that it ended up seeing release in its country of origin, as *Super Mario USA* in 1992. Western gamers would eventually receive their own version of the Japanese *Super Mario Bros 2* as part of the excellent *Super Mario All-Stars* compilation in 1993, with the new name *Super Mario Bros: The Lost Levels*. Since then, both of the Mario-branded releases have been made available to audiences worldwide via Nintendo's Virtual Console services.

## UM JAMMER LAMMY

### NANA ON-SHA 1999

Those of you who played this bizarre semi-sequel to *PaRappa The Rapper* might be wondering where the issue is, given that it's a family-friendly game. The problem lies in the plot, specifically for stage six. In the Japanese and European versions, this stage is preceded by a cut-scene in which Lammy receives an axe from a salesman. She heads out onto the street, only to slip on a banana skin and die. She then wakes up to find that she's in Hell and declares that since she's dead, the game must be over. A credits sequence begins to roll, but is interrupted by a pumpkin-headed man who declares that Lammy is the guitarist he needs, and brings her on stage at an idol concert. The idol threatens to kill Lammy for being late, but quickly changes the offer to instead revive her after Lammy points out that she's already dead.

In North America, the use of Hell was seen as inappropriate for a family-friendly game. In this version, Lammy instead snags her underwear on a doorknob and is catapulted through the town and off to a tropical island, where the pumpkin-headed man picks up the plot as before (with the exception that Lammy is to be sent home).

### JAPAN

[PlayStation] Lammy's final destination is Hell in the Japanese and European releases.

### USA

[PlayStation] While in the North American version, she simply snags her pants on a doorknob.

## PROBOTECTOR

### KONAMI 1988

The NES conversion of Konami's classic coin-op *Contra* is one of the system's most fondly remembered games, and also one of its hardest. But in Europe we don't remember it under that name, nor even under the arcade name of *Gryzor*. Instead we got *Probotector*, a sanitised version of the run-and-gun classic that replaced the player characters Bill Rizer and Lance Bean with robots, as well as most of the enemies.

This is an example of violence being edited out of a full regional release in order to satisfy a ratings board in one nation – in this case Germany, which forbade depictions of human-on-human violence. This set a precedent, and many subsequent *Contra* games were released under the *Probotector* name with similar edits made. Konami eventually started giving Europe games under the *Contra* name in the mid-Nineties, with far less fewer and less intrusive edits.

### EUROPE

[NES] Those of us in Europe get the rather more robotic *Probotector*, complete with miniature ED-209s.

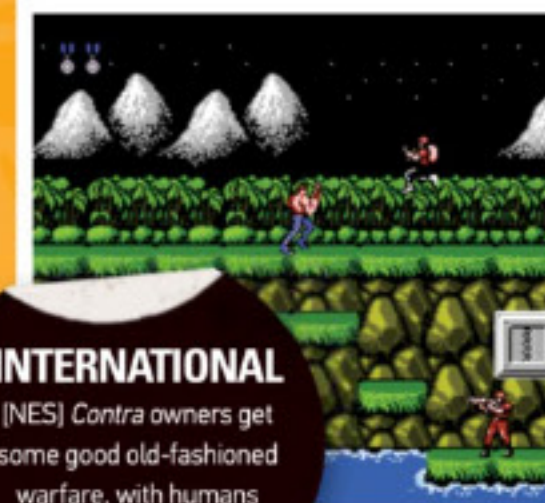

### INTERNATIONAL

[NES] *Contra* owners get some good old-fashioned warfare, with humans shooting humans to death.

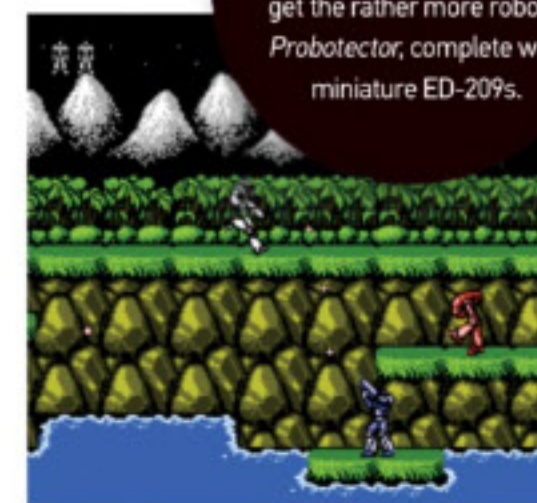

## STREETS OF RAGE 3

### SEGA 1994

The most divisive game in Sega's beat-'em-up series is a strange localisation case – the vast majority of the content in the international releases is unchanged from the Japanese original (titled *Bare Knuckle III*), but a wide variety of small changes makes for two very distinct experiences. The changes are so divisive that an English translation patch for *Bare Knuckle III* was actually released by fans, making it one of only a few games to be re-translated in this manner.

The biggest change to gameplay is that *Streets Of Rage 3* is far harder than *Bare Knuckle III*, with players given more enemies to beat, tougher bosses and fewer health pick-ups. However, there's also a missing mid-boss in stage one, who goes by the name of Ash. He's basically a rather offensive gay stereotype, complete with outlandish outfit and effeminate mannerisms, so it's not hard to understand why he was removed from international releases. Interestingly, Ash was one of the secretly playable mid-bosses alongside Roo and Shiva – and as that code wasn't removed from the international releases, you can play as him using a cheat cartridge.

Ash's removal wasn't the only alteration made in the name of taste and decency in *Streets Of Rage 3*, as the female enemies were redrawn to show rather less skin. The main characters also had their clothing altered into new colour schemes, apparently to provide a more gender-neutral appearance.

The other major change made to *Streets Of Rage 3* was the plot. The original Japanese story concerned the discovery of a new radioactive element which could be used in nuclear bombs – naturally, series villain Mr X was most interested in this development and deployed them throughout the game with the intent of causing all-out war. The localisation team didn't really care for repeated images of bomb blasts and a bad ending with a devastated city, so completely retooled the story as a result. The new plot focused on Mr X's rather less plausible plan to take over the city by replacing its officials with robotic doubles.

### JAPAN

[Game Boy] Let's be honest, this boss basically looks like he's a member of the KKK.



## KID DRACULA

### KONAMI 1993

Konami's cutesy *Castlevania* spin-off seemed a rather unlikely candidate for cultural sensitivity problems, but it definitely had them. In much of Asia, the swastika is not too much of a cause for concern as it was in use for centuries prior to its adoption by Nazi Germany. In its non-tilted form, it's a standard part of the Chinese character set and the left-facing version is used to denote temples on Japanese maps. As such, it occasionally crops up in games where spiritual imagery is used and doesn't cause any bother.

*Kid Dracula*, however, didn't just require editing for that reason – it had to go a bit further. The game employed cartoonish white-sheet ghosts as bosses, and in the Japanese version these ghosts bear the swastika symbol. As you might imagine, this brought up some very sensitive issues surrounding American racist groups, and so the sprites were rather hastily edited for export releases.

### INTERNATIONAL

[Game Boy] Rounding the tip of the cap and removing the swastika brings it back to ghost territory.

### JAPAN

[Mega Drive] It's easy to tell that this is the Japanese version, as Axel retains his normal clothes.



### INTERNATIONAL

[Mega Drive] Outside of Japan, these female enemies have been edited to show a lot less skin.

“The localisation team didn't really care for repeated images of bomb blasts and a bad ending with a devastated city”





# TABOO TOURISM

Some nations have very specific pet peeves – here's a sample...

## UK

■ The British Board of Film Classification (BBFC) took a very dim view of martial arts weaponry throughout the Eighties and Nineties, and would require it be cut from games it rated. 3D Realms' *Shadow Warrior* had to replace shurikens with darts, while *Soul Blade's* Li Long had his nunchaku replaced with a three-section staff.



## JAPAN

■ Japan's Computer Entertainment Rating Organization (CERO) has a range of age classifications, but only the 18+ Z rating is legally enforceable. Extreme violence is likely to earn the unwanted rating, with even Japanese-developed games such as *Resident Evil 4* and *Ninja Gaiden* lacking the decapitations found in export versions.



## GERMANY

■ Germany is famously strict about depictions of violence, and has laws forbidding the display of Nazi symbolism for obvious historical reasons. While films can receive an exemption on artistic grounds, games currently can't. The country only received its first *Wolfenstein* game in 2014, with all offending content removed during localisation.

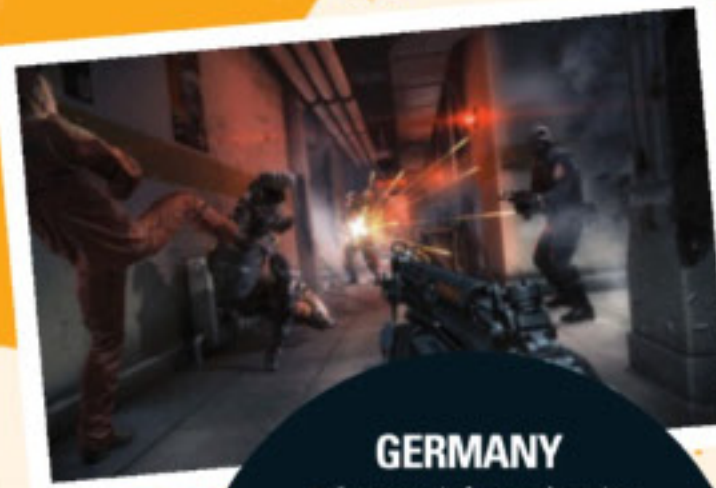

## SOUTH KOREA

■ Samurai are very unpopular in South Korea, thanks to historical conflicts with Japan. As a result, characters and titles referencing samurai are often removed during localisation – *Soul Calibur's* resident samurai Mitsurugi was replaced with an almost identical British swordsman named Arthur, while *Samurai Shodown III* was renamed *Fighters Swords*.



## USA

■ America's Entertainment Software Rating Board (ESRB) doesn't issue legally binding ratings, but most stores won't carry games with an 18+ Adults Only rating. Most of the titles carrying the AO rating contain graphic sexual content – games like *Fahrenheit* (released in North America as *Indigo Prophecy*) have required major cuts to avoid it.

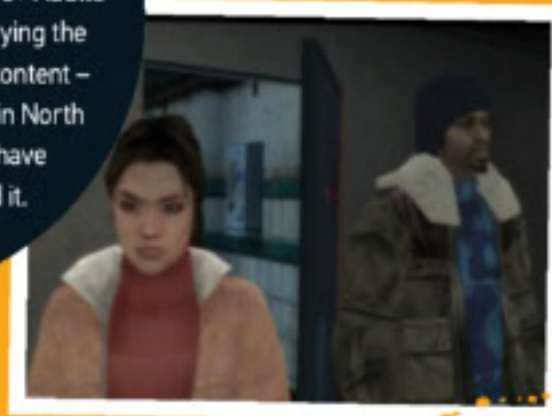

## CHINA

■ China is notorious for its media censorship, famously banning games which portray its army in a negative light or disagree with its territorial claims. Even *Football Manager 2005* received a ban for its handling of Tibet! The Ministry of Culture's regulations are very broad, often inspiring pre-emptive changes.



MAGIXBUTTONS.com

The Ultimate Retro Gaming Webshop!



# MAGIX BUTTONS

- Worldwide Shipping
- 10,000+ items in stock
- Quick Delivery
- 14 Day Return Policy
- Actual Product Pictures
- Ebay Powerseller
- PayPal, Bank Transfer & iDEAL

## NEW BIGGER VENUE! MORE TRADERS MORE BARGAINS 100+ TABLES!

RETRO  
COLLECT  
WHERE RETRO GAMERS... COLLECT

# VIDEO GAME MARKET

## SAT 7TH FEBRUARY 2015

### UK'S BIGGEST VIDEO GAME SALES EVENT!

EVERYTHING FROM VINTAGE COMPUTERS TO ARCADE MACHINES, MODERN GAMES & 16-BIT CLASSICS

STARTS 11AM @ VICTORIA HALL, LEEDS TOWN HALL, THE HEADROW, LS1 3AD - FIND OUT MORE: [HTTP://EVENTS.RETRCOLLECT.COM](http://events.retrocollect.com)

# Alien Breed: Special Edition 92

ALIENS AND TENSE BLASTING  
ACTION MAKE IT A BREED APART

RETROREVIEWAL



» AMIGA » TEAM 17 » 1991

Once upon a time I traded in a SNES collection of around 50 Japanese games for an Amiga 1200. It remains one of the biggest mistakes of my gaming life. I'd been entranced by the likes of *The Eye Of The Beholder* and *Indiana Jones And The Fate Of Atlantis*, crucially forgetting that two of my favourite types of games, shmups and arcade offerings, weren't well represented on the Amiga systems.

Thank goodness then for Team 17's *Alien Breed*. With its impressive visuals and atmospheric soundtrack, it reminded me of all the console and arcade games I used to enjoy on my SNES. It was a fantastic price to boot. I can remember almost wincing in pain when I handed over £70 for an import copy of *Super Star Wars*, so being able to pick up something as slick as *Alien Breed* for under a tenner was a fantastic feeling.

Playing it was just as enjoyable an experience thanks to Team 17 channelling the spirit of both *Gauntlet* and *Aliens* to create a tense and oppressive blaster, particularly when playing with a friend. Yes, the maps could be a pain to navigate and you'd often run out of keys before you could access specific areas, but there was something about Team 17's game that always dragged you back for one more go.

Even today there's something immensely satisfying about shooting your way through a sea of xenomorphs, and the metallic Bitmap Bros-styled visuals still hold up incredibly well. The game is admittedly simple in its execution – find exit, shoot aliens, pick up objects – but its quick pace and fun firefights still manage to entertain.

*Alien Breed* may have riffed heavily off other games – a Team 17 trademark – but it proved that Commodore's machine was more than capable of giving the consoles a good run for their money. I may have regretted losing that Super Nintendo, but the discovery of Team 17's game at least made the experience bittersweet. ★



# Top 25 Master System Games



Retro Gamer readers turned out in droves to vote for their favourite games on Sega's 8-bit console – Nick Thorpe has crunched the numbers and is about to begin the countdown...

## Operation Wolf

DEVELOPER: TAITO  
YEAR: 1990 GENRE: LIGHTGUN SHOOTER

**25** The Master System's Light Phaser peripheral got some excellent support over the years, and *Operation Wolf* is your favourite lightgun title on the system. The excellent conversion included all of the arcade game's stages and even allowed players to throw grenades using the second controller. In fact, it was such a good game that it became part of the Master System II Plus bundle in Europe, replacing previous lightgun pack-in *Safari Hunt*.

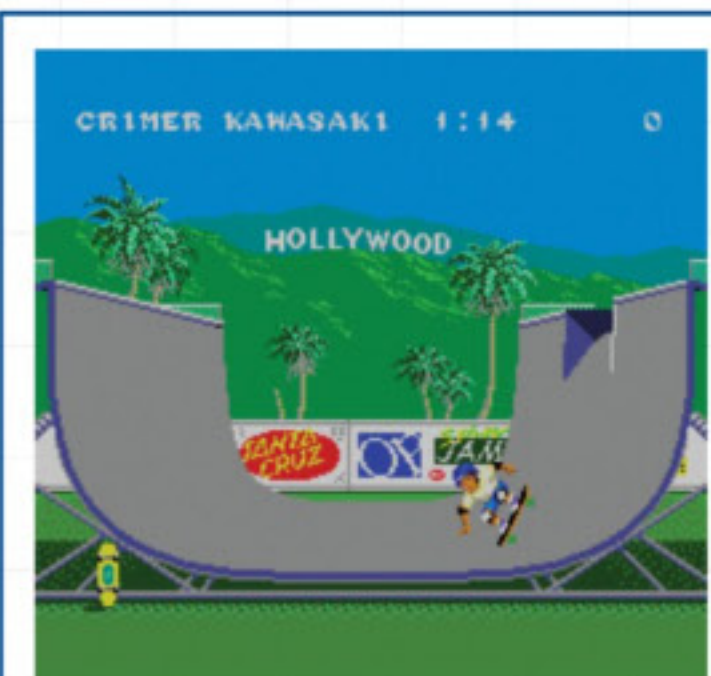

## California Games

DEVELOPER: SEGA  
YEAR: 1989 GENRE: SPORTS

**24** Despite having a large catalogue of arcade hits to draw on, Sega was keen to bring other big names to the Master System and so became rather active in the licensing market. These efforts ensured that Epyx's excellent multi-sports title found a perfect home on the Master System, with the console's colourful visuals really helping to bring home the sunny California feeling during each of the six events. There's a sequel too, but it doesn't live up to the original.

## Bubble Bobble

DEVELOPER: TAITO  
YEAR: 1988 GENRE: PLATFORM

**23** Taito was one of the few major third-party developers to ever support the Master System directly, with most firms licensing their titles to Sega to get around Nintendo's restrictive NES developer agreements. Conversions like *Bubble Bobble* certainly endeared the company to the console's owners – the game features a variety of enhancements including new items and brand new level designs, as well as new ending sequences. There's some slowdown and sprite flicker, but it's otherwise an incredibly faithful conversion.



## Master Of Darkness

DEVELOPER: SIMS YEAR: 1992 GENRE: PLATFORM

**22** We often see those who grew up with the NES dismissing Master System games as 'off-brand' versions of their childhood favourites, and while that's often not really the case, it's hard to describe *Master Of Darkness* as anything other than a *Castlevania* clone – albeit a very good one. It's a platformer in which you're out to kill Dracula, you fight all manner of supernatural enemies and even the stairs are drawn in the same odd way. However, since *Master Of Darkness* was only released in PAL territories, where the NES wasn't so dominant, there was a good chance that its players had never experienced *Castlevania* in the first place.

The storyline in *Master Of Darkness* sees psychologist and paranormal investigator Ferdinand Social taking a journey through Victorian London to investigate a series of murders in which the bodies have been completely drained of blood. This clearly isn't the work of Jack The Ripper – though you'll meet him as the first boss – and Social finds himself drawn into a nightmarish vampiric plot. *Master Of Darkness* is a very solid platform game, featuring some nice visuals and a wide array of supernatural enemies to slay, including ghosts, zombies and bats. It's also filled with memorable moments – we'll certainly never forget being trapped in a room with a succession of possessed waxworks rapidly chasing us down.

In fact, given its high quality we were surprised that *Master Of Darkness* didn't place a bit higher on the list, but your votes predominantly favoured worldwide releases from the days before the Mega Drive hit it big. As such, the fact that the game made an appearance on this list at all is a very strong indicator of just how good it is.



“Castlevania rip-off? Yup. But why not rip off something awesome? Plays great, and is a pretty decent challenge for most gamers”  
learnedrobb

“We'll never forget being trapped in a room with possessed waxworks”

Master Of Darkness gave us some memorable scary moments





### Golvellius: Valley Of Doom

DEVELOPER: COMPILE YEAR: 1988  
GENRE: ACTION-RPG

**21** At first glance, players unfamiliar with *Golvellius* might dismiss it as a simple *Zelda* clone, but they'd be wrong to do so. Compile's adventure includes a variety of different game modes – the overworld provides a similar experience to the aforementioned NES classic, while the dungeons offer traditional platform stages and forced-scrolling vertical battles, both featuring some gigantic and detailed enemy sprites. That variety helps to keep your interest levels high while wandering the game's vast map, which offers hours of play even for the experienced adventurer. Plus, you'll be drawn into the adventure quickly by the characters you meet along the way, as their taunts and quips go beyond the purely functional dialogue found in many games of its era.

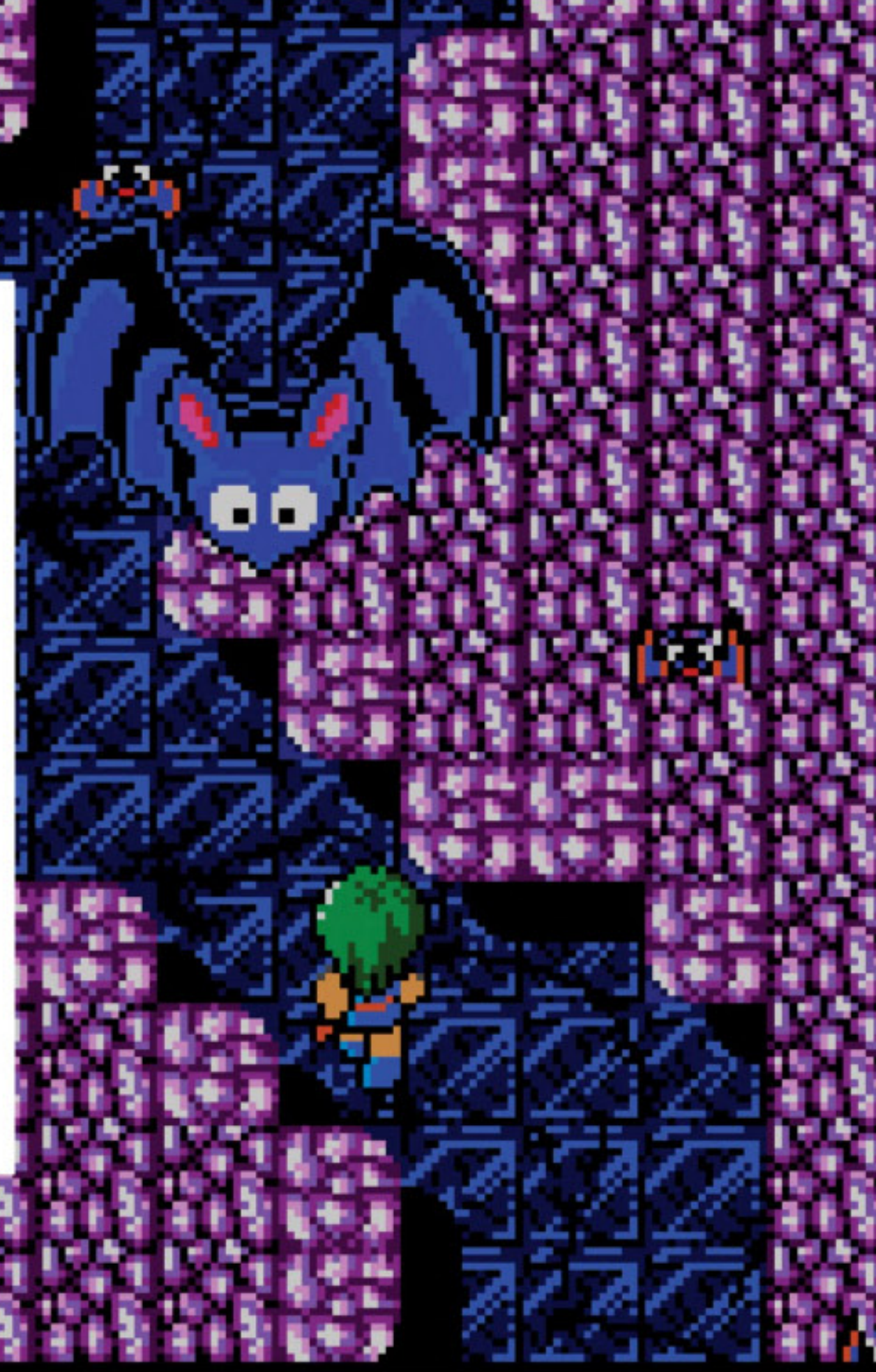

### Choplifter

DEVELOPER: SEGA  
YEAR: 1986 GENRE: SHOOT-'EM-UP

**20** The classic rescue-themed shoot-'em-up was one of the first games to make its way to the Master System, and was the most visually impressive of those early releases. It threw around a lot of sprites at very high speed, with some smooth faux-parallax scrolling serving as the icing on the cake. Confusingly, the Master System version of *Choplifter* is actually a conversion of a conversion: it's based on Sega's coin-op, itself an enhanced conversion of Broderbund's original computer game. This means it includes the extra environments and scoring mechanics of the arcade game, adding a bit of extra depth and visual variety over the home computer versions.



### Secret Commando

DEVELOPER: SEGA YEAR: 1986 GENRE: SHOOT-'EM-UP

**19** You might call it *Rambo: First Blood Part II* if you're in North America or *Ashura* if you're in Japan, but the European title makes no bones about Sega's homage to *Commando*, Capcom's classic arcade shoot-'em-up. Just like in that game, you wander up-screen shooting all manner of infantry grunts and blowing through end-of-stage fortresses. It's a bit slower than *Commando* and features rather chunkier sprites that seem to ape the *Ikari Warriors* style, but retains the two-player co-op play that makes these games so much fun, ensuring that you'll keep coming back.

### Asterix

DEVELOPER: SEGA YEAR: 1991 GENRE: PLATFORM

**18** For a console which thrived on platform games and was more popular in Europe than elsewhere in the early Nineties, a licensed *Asterix* platformer was more or less the perfect release. The setup is rather plain: the Romans are holding the druid Getafix captive, and without his potions the Gauls will be powerless to resist the imperial forces. However, the gameplay is fantastic. High-quality platforming is common on the Master System, but what sets *Asterix* apart is the fact that you can opt to play as Asterix or Obelix. The former relies on his small size and potions, while the latter offers brute, block-smashing strength. Each stage has two layouts, one tailored to each character's strengths, so you'll have a rather different experience depending on which one you pick.

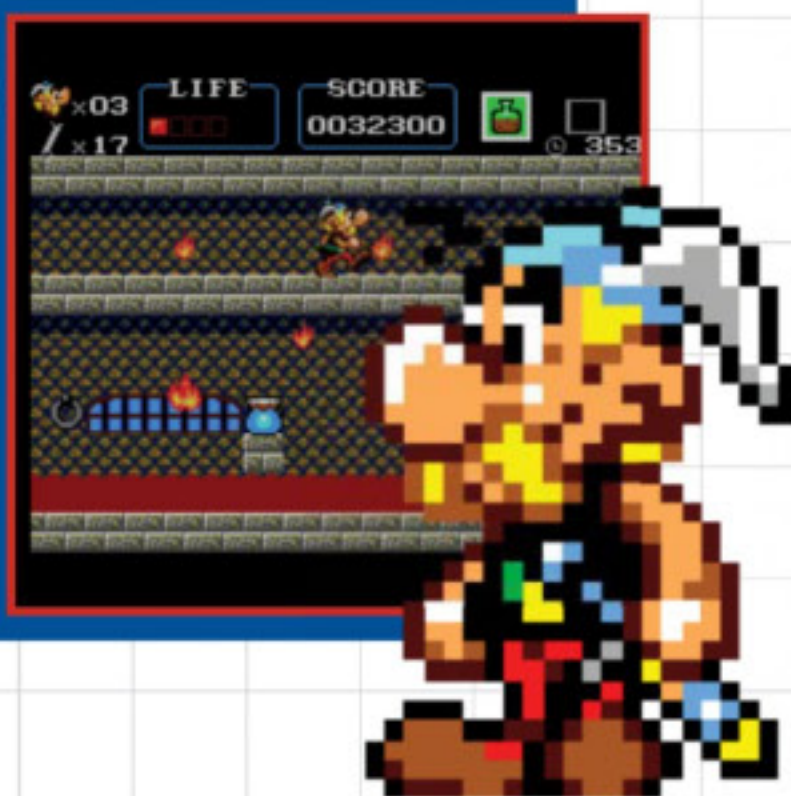

“Easily the best version of the classic game with its great graphics and more varied levels”  
The Laird

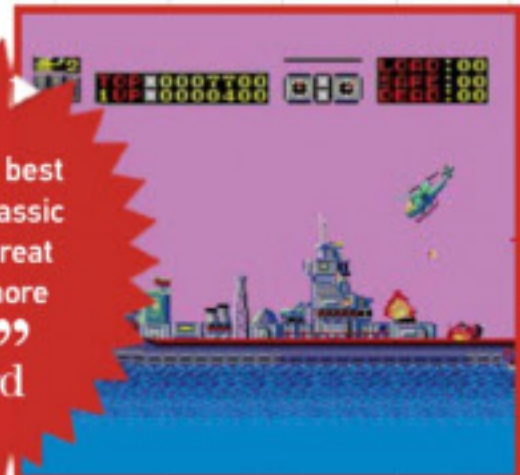

### Ninja Gaiden

DEVELOPER: SIMS YEAR: 1992 GENRE: PLATFORM

**17** When discussing forgotten entries in classic series, the Master System version of *Ninja Gaiden* demands a mention. Licensed from Tecmo but developed by SIMS, then a subsidiary of Sega, it's an entirely new adventure which retains many elements of the NES games while adding some twists of its own. Chief among these is a brand new wall-jump move, which replaces the climbing of previous games. While the visuals and music deserve praise, what makes the game so good is simply the joy of movement. Ryu Hayabusa is an incredibly agile chap, who moves quickly and is capable of navigating dangerous environments with ease. You'll feel like you have actual ninja skills when you've spent a while with the game, and slicing up bad guys is all the more enjoyable as a result.

“Rock hard, but so satisfying to control. I loved the first level's theme”  
SMD



“I was gutted as a kid when I found out it wasn't a straight conversion, but ended up enjoying it way more than similar 8-bit games”  
BellyFullOfHell

### Enduro Racer

DEVELOPER: SEGA YEAR: 1987 GENRE: RACING

**16** Despite the fact that ROM cartridges were unavoidably more expensive than the tapes and disks used for most home computer software, Sega and its distributors were keenly aware that price was a factor for many consumers and offered a range of lower-priced games. The budget-oriented Sega Card format didn't last too long, but Mastertronic had success in the UK by offering a range of titles for as little as £9.99 – and judging by comments we received, it seems that it was the price that persuaded many of you to buy *Enduro Racer*. The game itself is a bit of an oddball, as it doesn't really resemble Sega's arcade game of the same name, instead playing more or less like an isometric *Excitebike*. It stands up to extended play well, thanks to its varied off-road stages and an upgrade system that really makes a difference – you'll definitely notice if you're using a better engine or improved suspension. Take note: the Japanese Mark III version of *Enduro Racer* utilises a bigger cartridge than the Western release and boasts additional stages, more varied scenery and improved presentation as a result.

### Double Dragon

DEVELOPER: SEGA  
YEAR: 1988 GENRE: PLATFORM

**15** The classic Technos beat-'em-up made its way to the Master System via Sega. It's an excellent conversion featuring faithful level designs, all the enemies and even all the weaponry of the coin-op. Best of all, it includes the simultaneous two-player mode that the NES version lacked.



### The Ninja

DEVELOPER: SEGA  
YEAR: 1986 GENRE: SHOOT-'EM-UP

**14** This updated version of *Ninja Princess* is another game that many UK readers enjoyed as a £9.99 budget special. The fast-paced shoot-'em-up action is tough and it's hard to gather the five scrolls required to beat the game, but there's a lot of love for *The Ninja*.



### Wonder Boy

DEVELOPER: WESTONE  
YEAR: 1987 GENRE: PLATFORM

**13** The first *Wonder Boy* release isn't nearly as complex as later entries in the series, but that's why we like it – it's a straightforward dash to the end of each stage. This is a rather fine conversion of the coin-op, and we always did like the skateboard as a power-up.

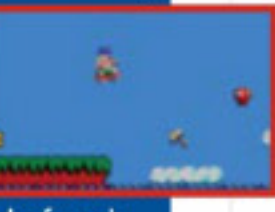

### Alex Kidd In Shinobi World

DEVELOPER: SEGA  
YEAR: 1990 GENRE: PLATFORM

**12** Originally planned as a parody game titled *Shinobi Kid*, Alex Kidd was drafted in to add some crossover star power. The result is a great game which adds more platforming to the *Shinobi* formula and more combat to *Alex Kidd*, and should still manage to satisfy both sets of fans.

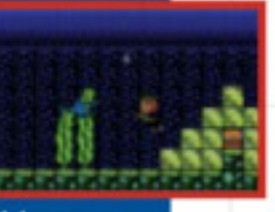

### R-Type

DEVELOPER: COMPILE  
YEAR: 1988 GENRE: SHOOT-'EM-UP

**11** *R-Type* received a number of fantastic conversions over the years, with the Master System's standing out as one of the best of the early efforts. There's some sprite flicker as you might expect, but it's otherwise amazing and an exclusive secret level really sweetens the deal.

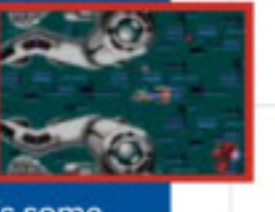



“Really hard and I only beat it once or twice, but the stages were a joy to play”  
Down By Law

### Out Run

DEVELOPER: SEGA ■ YEAR: 1987 ■ GENRE: RACING

**10** The Master System didn't always fare well with conversions of Sega's high-end arcade machines, often struggling to emulate the sprite-scaling effects that made them so impressive. However, the Master System conversion of *Out Run* is a very playable representation of the classic coin-op, including all 15 courses and the three memorable tunes of the arcade game.

While better conversions of *Out Run* have come along since the Master System's heyday, this one makes it into your top ten because of the impact it had at the time of release – it was the best home version around. Compared to the largely disappointing home computer releases, the colourful visuals and smooth movement of the console game seemed just like the real thing, lending credence to Sega's claims of arcade-quality games at home.



“At the time of release, it was the best home version around”

Out Run did a great job of emulating the classic coin-op



### Fantasy Zone

DEVELOPER: SEGA ■ YEAR: 1986 ■ GENRE: SHOOT-EM-UP

**9** Sega's trippy take on *Defender* is one of the earliest examples of the cute-'em-up, and the Master System conversion is excellent. While it had to drop the backgrounds in order to get the massive bosses on screen, it's otherwise visually faithful to the original, with bright colours and surreal enemy designs. The audio is also great, with close renditions of the arcade tunes. As for the gameplay, it's a very tight horizontally scrolling blaster which requires you to locate and destroy a series of bases in order to fight each end-of level boss. Defeated enemies drop coins to spend on power-ups, which you'll definitely need – this game is a stiff challenge despite its cartoonish visuals. We remember being utterly destroyed many, many times in our youth, but as with any great game, we kept returning for more punishment.

### Wonder Boy In Monster Land

DEVELOPER: SEGA ■ YEAR: 1988 ■ GENRE: PLATFORM

**8** The second arcade *Wonder Boy* outing was a world away from the simplistic platforming of its predecessor, retaining linear stages but introducing a currency system, shops, upgradeable weaponry and armour, and even people to converse with. There were plenty of secrets to discover too, with health and cash stashed all over the place and even hidden doors to find. The fusion of RPG elements and arcade platforming was a big hit with players, and the change of format would eventually prove to be a permanent one. The Master System conversion kept up with the coin-op due to some impressive visuals and the same cross-genre gameplay. It's a fantastic game, and remarkably one which set the stage for even bigger things to come...



### Castle Of Illusion Starring Mickey Mouse

DEVELOPER: SEGA ■ YEAR: 1990 ■ GENRE: PLATFORM

**7** For a time in the early Nineties, it seemed that picking up a Disney platform game was a guarantee of quality – Capcom turned in some fantastic NES releases, while Sega kept its own crowd happy with the likes of *Castle Of Illusion*. Minnie Mouse has been kidnapped by the evil witch Mizabel, and it's up to Mickey to gather the seven rainbow-coloured gems and bring her back.

Despite the Master System being targeted at a younger audience following the release of the Mega Drive, the 8-bit version of the game is noticeably harder than its 16-bit counterpart. That's not for bad reasons either, as the new level designs are tough but fair. It isn't quite as visually lovely as the Mega Drive game, but it'll certainly last you a whole lot longer – and it seems you all appreciated that.

“Different from its Mega Drive counterpart but still full of charm – I might even say I enjoy this version more”  
Black Ridge

“Still has more ambition than most modern RPGs. Three whole worlds and space travel!”  
Alexlotl



### Phantasy Star

DEVELOPER: SEGA ■ YEAR: 1987 ■ GENRE: RPG

**6** Alis Landale's quest for vengeance against King Lassic is one of the all-time great RPGs, and was highly influential in the development of the genre on consoles. The large 4-megabit cartridge enabled a huge amount of visual variety and a truly epic quest for the era, the smooth animation of the first-person dungeon scenes was a sight to behold, and the game even let players save via battery backup. However, that technology meant *Phantasy Star* was a pricey release, which we suspect is why it failed to crack the top five.



### Shinobi

DEVELOPER: SEGA ■ YEAR: 1988 ■ GENRE: RUN-AND-GUN

**5** The first of Joe Musashi's adventures received an excellent Master System conversion, which included all of the arcade stages and enemies but also provided a number of updates for the home audience. Joe could now sustain multiple hits before death and didn't have to rescue all the kidnapped kids, though it was still a good idea – they represented the only way to get new weapons, regain health and access the classic bonus stages. These enhancements helped *Shinobi* to become your top Master System arcade conversion, and we can't argue – it's ace.



### Psycho Fox

DEVELOPER: VIC TOKAI ■ YEAR: 1989 ■ GENRE: PLATFORM

**4** In the days before *Sonic The Hedgehog*, fast-paced platformers were rare, but *Psycho Fox* was one of them. Taking the basic gameplay template of NES platformer *Kid Koal*, it stars a fox which can transform into a variety of creatures – a hippo with a powerful punch, a monkey with a high jump and a really speedy tiger. Top-notch stage design and tight controls ensured the game's success, and Vic Tokai's momentum-based platforming template would later be used for *Decap Attack* on the Mega Drive.

### Sonic The Hedgehog

DEVELOPER: ANCIENT ■ YEAR: 1991 ■ GENRE: PLATFORMER

**3** While *Sonic* might have been created to promote the Mega Drive's strengths, Sega wasn't going to deny its 8-bit customers a chance to experience its exciting new mascot. But with Sonic Team busy creating the full-powered 16-bit version, Sega didn't have the resources to develop it in-house – enter Ancient, a new team co-founded by notable gaming musician Yuzo Koshiro. Knowing that a straight conversion of the Mega Drive platformer would be impossible, the team instead opted for a loose adaptation which lost a little of the speed and all of the loops, but remained faithful to the spirit of the original.

In fact, it's even arguable that the Master System version of *Sonic The Hedgehog* is actually a better game than its 16-bit counterpart. It might be missing a few of the flashier tricks, but the game includes completely exclusive stages with more varied level design, including gimmicks such as an auto-scrolling stage, an entirely vertical stage and a proper maze that had no place in the Mega Drive game. And while only the title theme and Green Hill Zone music remain from Masato Nakamura's iconic soundtrack, Koshiro's new music is of equally high quality.

This game set the tone for Sonic's later Master System outings, both of which would be completely disconnected from the Mega Drive releases. It served an interesting dual role, too – it was the final game for the Master System in North America, but in Europe it replaced *Alex Kidd In Miracle World* as the Master System II's built-in game, serving to extend the life of the console by bringing in thousands of new Master System owners. However, whether you experienced it as a swansong or an introduction, it's hard to deny that *Sonic The Hedgehog* is an excellent platformer which deserves its high place on this list.

“Arguably a better game than its 16-bit counterpart”  
Master System Sonic impressed with is more varied level design



“Not only the better version of Sonic, but one of the best Sonic The Hedgehog games ever made to this day”  
sambain81



“The perfect bundled game. Bags of character and variety, loads of replay value”  
ivortheinjun

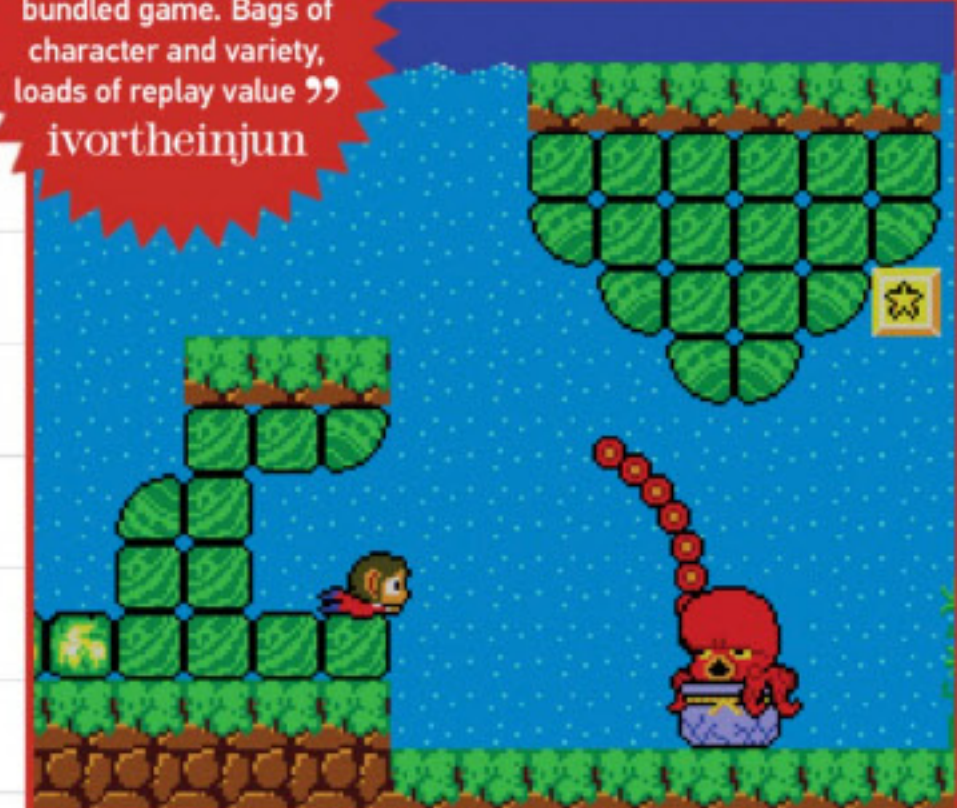
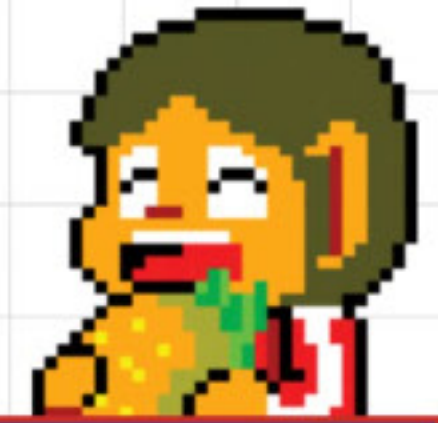

### Alex Kidd In Miracle World

DEVELOPER: SEGA YEAR: 1986 GENRE: PLATFORM

**2** You had to know that if Sonic was high on this list, his predecessor as Sega's mascot wasn't going to be too far away. Despite having received five games on the Master System, it's Alex Kidd's debut that stands the test of time as the strongest instalment in the series and one of the strongest games on the console. *Alex Kidd In Miracle World* owes a lot to Nintendo – the game takes inspiration from the incredibly popular *Super Mario Bros*, with its visual similarities and destructible blocks showing the influence clearly. However, Alex's choice to punch the blocks instead of headbutting them is only the start of the differences.

While Nintendo's hit is a fairly simplistic platform game, Sega loaded its release with features that keep the gameplay varied. While Mario's coins existed solely to provide extra lives, Alex can spend the money he collects in shops throughout the game. He can also store items to use later on, a feature which would eventually be added to Nintendo's series, and even ride vehicles such as a motorbike and a speedboat. The rock-paper-scissors boss battles seem like a strange inclusion, but for many they're simply a part of the game's unique charm.

Sega's fortunes never benefited from Alex Kidd in the same way as Nintendo's did from Mario, but it's not hard to explain why this game placed so high in your list – it was built into all North American Master System II consoles and a great many of the European ones, ensuring popularity from the get-go. Gamers would return to their cartridge-free consoles time and time again to play it, and they were rewarded with the kind of lengthy, challenging platform adventure that is not commonly surpassed on any format. In fact, on this console only a single game manages to do so...



“Loaded with features for varied gameplay”  
Alex Kidd is far more than a Super Mario Bros variant



“Picked this up when I was eight because I thought the cover was awesome, then never played anything but this for a year!”  
Lorfarius



### Wonder Boy III: The Dragon's Trap

DEVELOPER: WESTONE YEAR: 1989 GENRE: PLATFORM

**1** If there's one thing the Master System excels at, it's definitely platform games – the genre is clearly dominant in this top 25, so only a platformer of exceptional quality could possibly rise to the top. Described in a 95% *Mean Machines* review as “one of the best games of its type available on any console,” it's fair to say that *Wonder Boy III: The Dragon's Trap* is a platformer of exceptional quality.

Beginning in the final level of *Wonder Boy In Monster Land*, you get the chance to fight the final boss of that game again – but this time, defeating it reveals a nasty surprise. Our plucky hero is cursed upon the dragon's defeat, transforming him into a fire-breathing lizard. He escapes the collapsing castle but now needs to become human again, so a new quest begins, taking him to locations such as a spooky forest, a dry desert and a fiery cave. That sounds like standard fare for the series but unlike its predecessor, *Wonder Boy III* doesn't contain individual stages. Instead, it takes place in a single large world where everything is connected and you're only limited by the obstacles you can overcome.

Of course, as a lizard you can't overcome too many obstacles, but during the journey you'll encounter more dragons and be transformed into new animal forms. The first is a tiny wall-scaling mouse, while later ones include a lion with a massive sword swing and an eagle which can fly. All of these forms enable you to visit new areas and access new areas in old ones, creating the feeling of a grand adventure where undiscovered secrets could be hiding anywhere.

The *Metroid*-esque structure is certainly great, but it's far from the only thing that makes *Wonder Boy III* so good. The controls are dead-on while the vibrant, detailed visuals are superb and sprite flicker is kept to a minimum. In some places, the game almost reaches the visual quality of early Mega Drive releases. The soundtrack contains a number of superbly composed tunes and even supports the FM add-on for improved sound, despite never having been released in Japan.

*Wonder Boy III* would be a great game on its own, but as a sequel it really acts as a model for others to follow. New players are brought into the action quickly thanks to the game's inspired introduction, while old fans have a whole new structure and new abilities to play with. It's telling that *Castlevania: Symphony Of The Night*, a PlayStation classic considered by many to be the pinnacle of that series, shares a lot of its design traits with *The Dragon's Trap*. It just goes to show that while **Retro Gamer** readers have voted for *Wonder Boy III: The Dragon's Trap* as their favourite Master System game, its design principles ensure that it would be an exceptional game on any platform.

### 5 reasons why it's great

- It's a truly epic adventure, requiring multiple nights of play and password saves to reach the ending.
- Each of the different transformations feels truly unique, changing the way you play the game.
- It's a great example of the Master System's visual strengths, with colourful graphics and detailed backgrounds.
- Shinichi Sakamoto's soundtrack is fantastic, and should get far more recognition – there's even an FM version!
- Beginning from the final level of the previous game is one of the greatest introductions to any game, ever.



## THE MAN WHO BUILT BUILD

"I started my initial research in the March of 1993 and one of the companies I sent the demo to was Apogee," says Ken Silverman, creator of the Build engine. "George Broussard sent copies to his various teams and Nick Newhard took it up with a project tentatively called 'Horror.'" Ken and Nick would subsequently discuss the engine at least once a week, working on the original grid-based version before Ken scrapped it and rewrote it to use sectors early in 1994. *Blood* would subsequently utilise an early method of creating 3D sprites called voxels. "Voxel sprites are 3D models made up of a grid of cubes," explains Ken, "and in my format only the cubes at the surface were actually stored and rendered. It was nice being able to walk up to something and it not being a cardboard cutout, but my editor back then was very difficult to use and the reduction in frame rate when using voxel sprites were big reasons why they weren't used more." As a result, in *Blood*, voxels were used mainly for ammo pick-ups and the occasional piece of scenery.

in mind that the Build engine was both pre-*Quake* and pre-Direct X," notes Nick. "Heck, the closest I'd personally been to having access to an actual 3D engine at that time was used in *Ultima Underworld*." Apogee planned to fund and publish a number of games with Build, yet despite the engine's relative freshness, Q Studios was keen to expand on and improve the base of its game. "I architected all the core systems for *Blood* – basically everything game-related that wasn't handled by Build," recalls Peter. "I also extended the engine quite a bit – sometimes with Ken's help. We had some pretty advanced technology in *Blood* that wasn't in the other Build games, like our 3D sound and resource caching systems." Peter also built and extended the tools used to create the game content, such as creating a keyframe-based animation tool for the weapon overlays which allowed the team to easily manipulate various layers for the weapon fire animations and muzzle flare effects. In addition to Peter's work, Ken Silverman was constantly developing the engine and experimenting with new ideas. "At some point he added ▶



**“We had some pretty advanced technology in *Blood* that wasn't in the other Build games”**

Peter Freese recalls how he extended the standard Build engine and tools

Studios was incorporated into Apogee with the goal of developing *Blood* – a first-person shooter using the Build engine." At this point the game was simply known as 'Horror 3D' and Nick recruited Peter Freese into his team. "Nick was basically the visionary behind the project," says Peter, "and he and I had worked at an early educational company called Edmark in the early Nineties." Peter was working at another developer when contacted by Nick to see if he'd be interested in helping out with some of the AI routines on Horror 3D. Q Studios, formed in November 1993, now consisted of Nick Newhard, Peter and an artist, Kevin Kilstrom. "It was really a 'garage start-up,'" says Nick, "although actually it took up my entire family room and two bedrooms. I was recently married and my wife was thrilled at the idea of having a games company in the house with employees there at all hours," he smiles. "All joking aside, Helen was a real peach about it and even pitched in as bookkeeper and late-night playtester."

So let's recap. Nick Newhard, approaches Apogee and sets up Q Studios, funded by Apogee, to develop Horror 3D using the Build engine. "Keep



[DOS] Seven years' bad luck?



### IN THE KNOW

- » PUBLISHER: GT INTERACTIVE
- » DEVELOPER: MONOLITH
- » RELEASED: 1997
- » PLATFORM: MS-DOS
- » GENRE: FIRST-PERSON SHOOTER

The grizzled ex-gunslinger Caleb, head of the The Cabal and one of four 'Chosen', kneels before his god, the

evil Tchernobog, not knowing why he and the others have been summoned. With a dark voice laced with rusty razor blades, Tchernobog utters its dissatisfaction; they have failed the forgotten god and must pay the ultimate price. With a short, brutal, clench of its fist, Tchernobog sucks the life from them; Caleb, his lover Ophelia, Gabriel and Ishmael are dead. Thus inexplicably slain by the very god he worshipped, the Cabal leader is no more. Until...

Development on *Blood* can be traced back to as early as 1993, although its origins are somewhat muddled. Or rather, blood-stained. "Speculation about how *Blood* came about has been amusing to those of us who lived it," says Nick Newhard, creative lead and main designer on the game. "I approached Scott Miller and George Broussard of Apogee with the idea of forming a game development team in Seattle. There were a lot of negotiations and the end result was that our team, Q

While the most famous Build game remains Duke Nukem's popular third outing, Ken Silverman's '2.5D' engine also produced several other titles. Graeme Mason chats to two of the men behind the derivative, violent and jolly entertaining undead romp *Blood*

# BLOOD



**DEVELOPER HIGHLIGHTS**  
**SHOGO MOBILE**  
**ARMOR DIVISION**  
**SYSTEM:** Various  
**YEAR:** 1998  
**THE OPERATIVE: NO ONE LIVES FOREVER**  
**SYSTEM:** Various  
**YEAR:** 2000  
**ALIENS VS PREDATOR 2 (PICTURED)**  
**SYSTEM:** Windows/Mac  
**YEAR:** 2001



► voxels [into the engine]," remembers Nick, "and we incorporated them once the kinks were worked out and we had the tools to make them."

With Peter taking care of much of the technical side and Kevin Kilstrom the graphics, Nick was busy designing levels, implementing many of *Blood's* cool features and helping develop its macabre plot. "HP Lovecraft was definitely a design influence throughout," he reveals, "and the original design for *Blood*—one gamers never saw—had a much darker and more serious plot." Nick cites George Broussard for pushing the game towards a more comedic angle as the plot wholly embraced a dark humour which he credits in part towards *Blood's* commercial success. Remembers Peter: "We'd all planned for *Blood* to be a serious horror game, hence the 3D sound. And we spent a lot of time coming up with ideas to immerse the player and scare the crap out of them." When the programmer saw the direction the game was taking, he recognised it was likely for the best. "It probably helped that Kevin was a big fan of Bruce Campbell and had the film *Army Of Darkness* playing repeatedly in our tiny office space!" he laughs. Says Nick, "We would regularly watch horror movies at Q Studios, so avoiding cross-contamination from all those flicks was

## BLOOD FACT FILE

- The evil god Tchernobog is derived from the Slavic 'Czernobog' meaning Black God.
- 'Beast' mode, when Caleb would transform into a powerful werewolf-like creature, was abandoned as the team felt it didn't work properly.
- Early plots included a man escaping from a secret government lab and someone avenging the death of their family by alien demonic forces.
- Movies that influenced *Blood*: *Hellraiser*, *The Keep*, *The Crow*, *Halloween*, *The Fugitive*, *Jaws*, *Ghost*, *Apocalypse Now* and, of course, *Army Of Darkness*.
- Nick Newhard's favourite levels are The Phantom Express and The Overlooked Hotel.
- *Blood's* multiplayer arena is aptly named Bloodbath.
- Bloodbath has a handicapping system devised by Peter Freese if you run the game with the -skill N parameter.
- Much of the final plot must be credited to Monolith's Craig Hubbard.
- Caleb was originally intended as a straight heroic character. Artist Kevin Kilstrom changed all that when he created a delightfully demonic Caleb doll.
- Nick admits that the balance of the game was affected badly by the life-leech weapon and some devilishly troublesome machine-gun-toting cultists.
- Monolith CEO Jace Hall contributed much to the game, including helping to balance multiplayer and providing the voice of Tchernobog.

impossible. Often the process began with Kevin, he'd mention a quote or joke that had us all laughing, and next thing you knew something from the movie made it into a sprite, game text or level."

The team was also tightly focused on how the game 'felt' to players, as coder Peter Freese explains. "I think I spent two whole days trying to reverse-engineer *Doom's* control acceleration. After painstakingly recording rotational speeds and keyboard acceleration, I implemented what I believed to be a



► [DOS] Take one lighter, add one aerosol and you've got an effective if incongruous weapon.

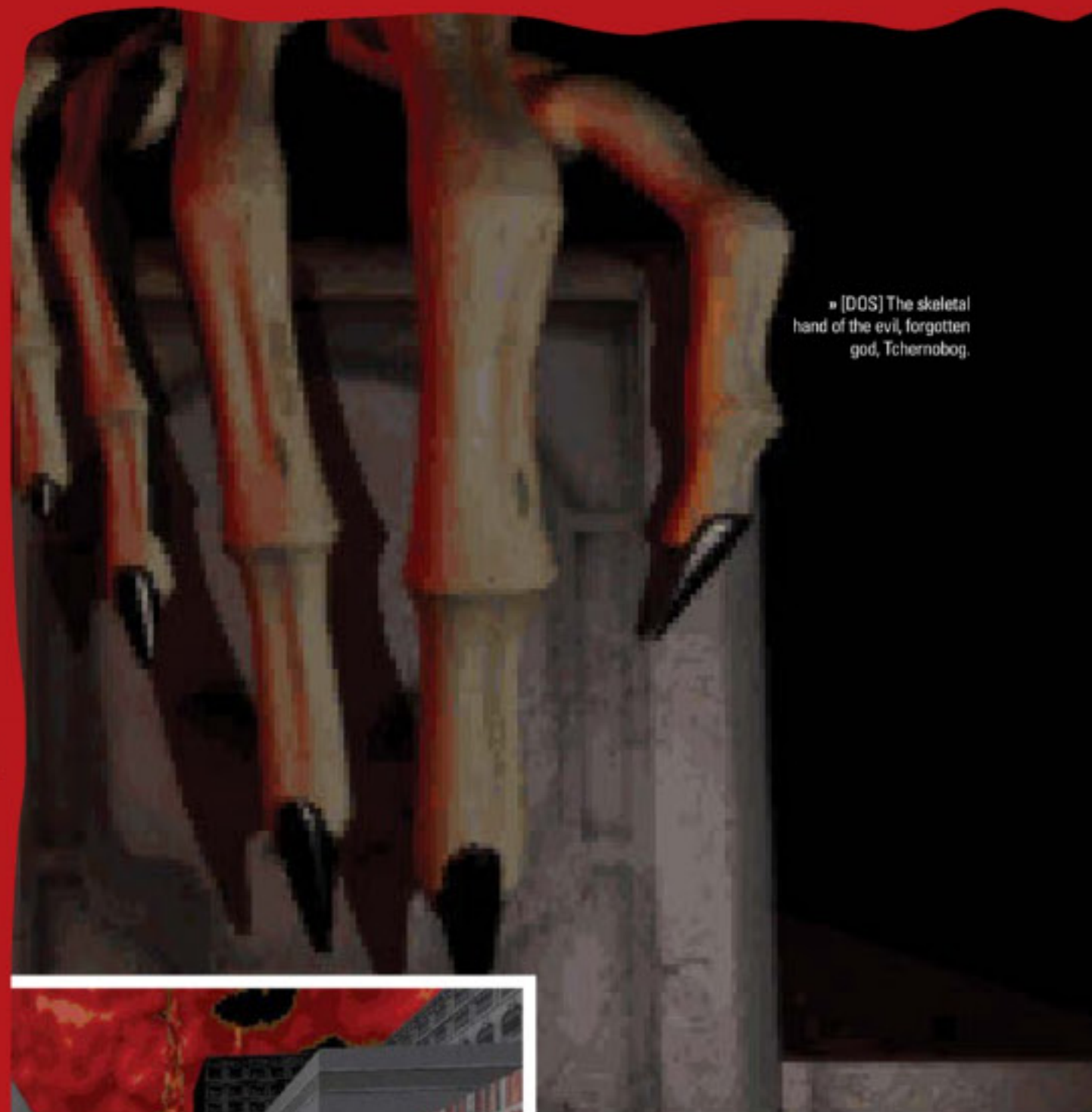

► [DOS] The skeletal hand of the evil, forgotten god, Tchernobog.

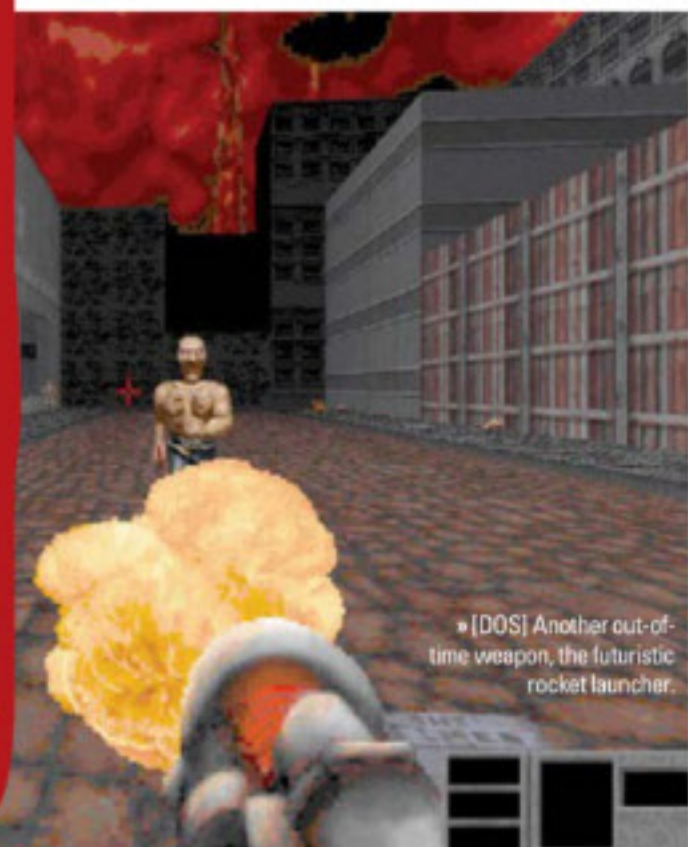

► [DOS] Another out-of-time weapon, the futuristic rocket launcher.

similar system in *Blood*. I showed it to Nick and he said 'Nope, that's still not right!'" Peter returned to his code to try to figure out why a few milliseconds difference in timing made the controls feel different. "Nick was really hard to please when it came to this, but I think it was the right thing to place so much importance to it. There were several *Doom* clones out while we were in development and many of their controls were just abysmal."

While the development of *Blood* may sound like the best fun ever, of course it wasn't. "We never had enough money to do all the things we wanted to do," continues Peter, "and our entire budget from 3D Realms [into which Apogee had morphed] was something like \$15K a month at its peak, with which we had to pay our entire team and operating expenses. The tight finances put a huge strain on everyone involved and we constantly looked for other sources

to help fund the development." This was reflected in aspects such as 3D modelling, which was way beyond budget and the experience of the team. "Kevin was a traditional artist and sculptor," notes Nick, "with no 3D experience and we had no access to 3D tools. So we went old-school and put together a green-screen rig. Kevin either built or scanned nearly every sprite in the game and hand-drew and animated everything else."

**D**espite being hugely invested in *Blood*, Peter Freese, under the strain of constant work for three years, opted to take

a break from the games industry for family reasons. "I took my leave as we transitioned from Q Studios to Monolith. It helped knowing Monolith was run by friends [with] the backing to bring *Blood* to fruition," he says. The Washington-based developer had acquired Q Studios in the winter of 1997 and as part of the merger gained the rights to *Blood* from 3D Realms, which was now busy on fellow-Build title *Shadow Warrior*. And with *Duke Nukem 3D* proving to be a roaring success, Monolith CEO Jace Hall pushed the project onwards at pace. Level-designer Jay Wilson was already on board ("He was working as a theatre usher before... so he was pretty happy with the transition to getting paid to make game levels," laughs Peter) and the change to Monolith saw more hands to the pump such as Craig Hubbard, hired to flesh out *Blood's* plot.

We return to Nick now and enquire whether he ever met any resistance to

the graphic intensity. "From my earliest discussions with George and Scott we never wavered from the goal of making the game as graphic as possible," he says, "and we never got much flak for it. Games like *Postal* drew way more attention from uptight politicians such as Senator Liebermann, so perhaps the dark humour was our saving grace." Part of this humour lay in the weapons that Caleb can wield throughout the game. A pitchfork, flare gun and even a voodoo doll (the life leech) can be used to eliminate enemies in a variety of amusing and satisfying ways. "I wrote up a bunch of ideas for weapons Caleb could acquire during the game," recalls Nick, "and added improvisational ones such as the lighter/spray can." Despite the (approximate) 1920s setting, the team were prepared to forsake reality in order to have some really cool weapons. Meantime, the odd ethereal feel to many of the game's levels came from Nick's experimentation with level design principles such as lighting, transparency, slopes, wall sprites, and sector controls and stacking. "I would put it all to the test in a level," he reveals, "and often I ended up with a fantastic-looking area or some really great-looking effect, but not a complete level, and these found their way into larger maps."

As development continued apace early in 1997, two vital new men lent their talents to *Blood*. Firstly, Stephen Weyte arrived to provide the gravel-toned voice of Caleb himself. "The dark humour even infected Stephen," smiles Nick, "as we didn't discover Caleb's love of show tunes until he started warming up during our recording session!" Secondly, the moody and sombre music to *Blood* was the work of composer Daniel Bernstein, who also contributed what would eventually be dubbed 'Dark Wisdom' in *Blood II*. In other words, the strange mix of Latin and Sanskrit that Tchernobog's demented cultist hordes used as a language.



► [DOS] Mmmmm dynamite.

As *Blood's* deadline loomed, the team found themselves facing an additional challenge. "Very late in production we were playing the capture the flag mod in *Quake*," Nick explains, "and we found it so engaging, we spent the next 36 hours coding it into *Blood*."

As this was added, another feature, a mode called Bloodlust in which Caleb would transform into 'The Beast' and need to maintain a constant slaughter in order to retain the powerful form, was abandoned. "We sort of had it working," says Nick, "but we actually cut it because it kind of sucked in melee combat and didn't contribute to the fun."

**“We never wavered from the goal of making the game as graphic as possible”**

Nick Newhard says they stuck to their guns

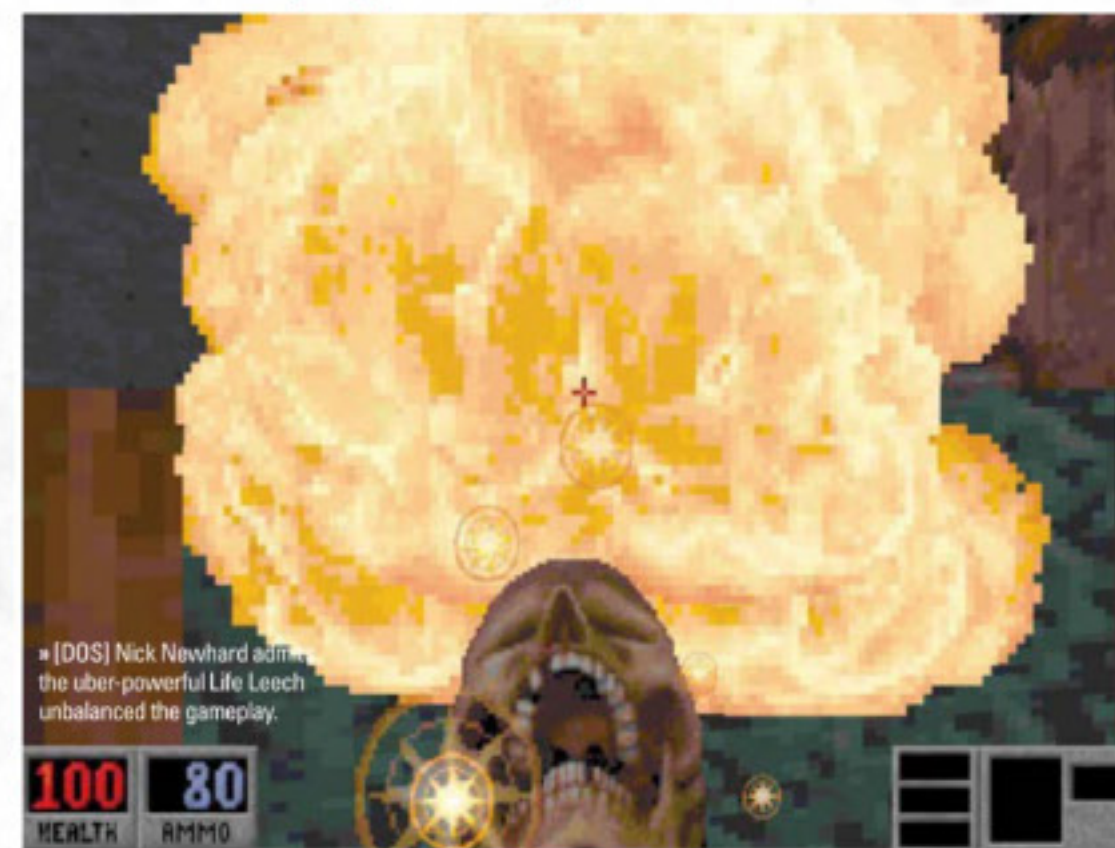

► [DOS] Nick Newhard admits the uber-powerful Life Leech unbalanced the gameplay.

## KNOW YOUR FOE

### ZOMBIE

■ The most common enemy in *Blood*, they're fairly simple to dispatch in low numbers but troublesome when they swarm. Most weapons are effective, but their melee attacks often force Caleb to use his pitchfork.

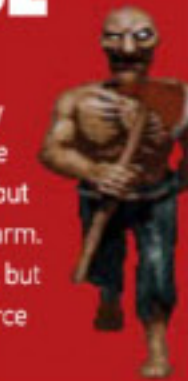

### CRITTERS (Rats mainly)

■ One of the most annoying enemies in the game, these are introduced early on and quickly home in on Caleb's toes. Better not to waste ammo on them and pitchfork the little gits.

### CULTISTS

■ Tchernobog's followers boast ranged weaponry, so best to engage close up. Use the flare gun and watch them glow before satisfyingly exploding in a mass of crimson viscera.



### SPIDERS

■ Another foe that's annoying rather than actually much danger and its low hit point count means they can be killed with most of the weapons Caleb has at his disposal.

### FAT ZOMBIE

■ These greedy swines have more hit points and better weapons compared to their slimmer counterparts. Why not light up some dynamite and watch them buuuuuuuuuurn?



### GARGOYLE DEMONS

■ Now we're getting nasty: Swirling around and launching teeth-first against Caleb, these distinctly un-stone-like gargoyles are best dispatched at close range. Close range you say? Say hello to the saved-off shotgun.

### HELLHOUND

■ These vicious hounds need taking down quickly lest they tear poor Caleb to pieces. Best break out the Tommy Gun and spray lead. Down boy!



### MIME

■ Okay, not strictly an enemy, but then why is it so satisfying to kill? Taking out the mime may be a guilty pleasure, but it's one that works with any item in Caleb's arsenal, invisible wall or not.

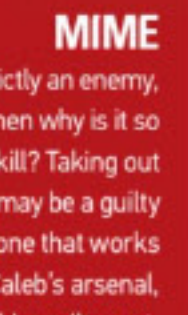

## THE MAKING OF: BLOOD



► [DOS] Monolith themselves have a little cameo in *Blood*.

It was one of those things that sounded great on paper but failed in gameplay."

In spite of criticism of the Build engine (which was starting to look a little creaky thanks to *Quake*), *Blood* received generally positive reviews and we asked Nick why he thought so. "Blood stood out for a number of reasons, starting with its core gameplay—single-player and bloodbath. I'd also point out the attention to detail throughout the game. The movement was tight, the single-player levels were huge and fun to explore, the weapons, alt-fires, positional audio, special effects... all of that plus the great gameplay." In addition to *Quake*, the game was also up against fellow-Build title *Shadow Warrior*, which acted as the primary motivation to the team for getting the game out as soon as possible. Nick also reserves particular regret for releasing too much content in the shareware version of *Blood*. "We should have released fewer levels and weapons and would have probably garnered more sales at retail," he grimaces.

Nevertheless, both Nick and Peter look back very fondly on the crimson-tastic FPS. "It was my 'first child' and years of effort for a small and dedicated core team that worked tirelessly on its release. And we really made a gamer's game and to this day our Bloodbath mode was the most frenetic and fun multiplayer mode I've ever experienced," says Nick, while Peter concludes: "Despite the bittersweet regret for all the things we didn't manage to get in to it, I'm definitely proud of the game. And if anyone wants to fund *Blood 3*, then count me in!"

Caleb stands before Tchernobog's temple. In his coarse, sandpaper voice, he asks why the Chosen were slaughtered. The evil god looks down upon the lone figure whose great power it now covets and wishes to use to take over the world. "Mmmm is that so?" growls Caleb solemnly, drawing his trusty flare gun and preparing for one final, decisive, battle with the god and its minions. ★

**Our special thanks to Nick Newhard, Ken Silverman and Peter Freese.**

# My Gaming Memories...

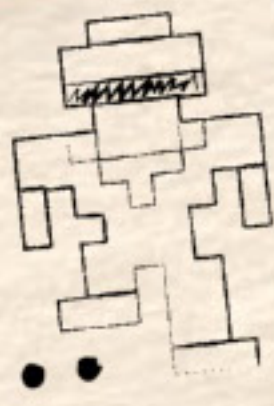

I WOULD HUNT DOWN ARCADES WHEREVER I WAS

Archer Maclean

Archer doesn't just have fond memories of the arcade – he maintains a collection of golden age games.



From this...

We speak to Dropzone, International Karate and Mercury developer Archer Maclean about a subject that's very close to his heart – classic arcade games



MY GAMING MEMORIES: ARCHER MACLEAN



...To this

Archer actively restores many of his games – here's the Space Invaders cabinet he mentions.

### What's your earliest memory of visiting an arcade?

I was a kid on a school trip to the seaside town of Bude in Cornwall, in 1972 or 1973, and got hooked on a strange-looking yellow machine with a moving white dot and beeps coming out the back. It turned out to be an original Atari/Syzygy arcade game with 'PONG' painted across the top, which then took all the money in my pocket, that wasn't actually mine to spend, and got me into trouble.

### What's the first arcade game you can remember playing?

As mentioned above, I was hooked on Pong from a very young age. As a kid in the Seventies I would hunt down arcades wherever I was, and have vivid memories of all the first-time encounters with games like Breakout, Tank, Night Driver, Star Castle, Space Invaders, Asteroids, Defender and so on. In 1979 I had a part-time job for a local electronics company and they put a Space Invaders cocktail in the shop area – sure enough the staff, customers and myself constantly played it day and night until it broke through overuse!

### Did you visit any arcades in your younger days? What were they and why did you go there?

I used to skive off school, catch a train into London and head for Tottenham Court Road / Charing Cross / Leicester Square where there were dozens of arcades at that time.

I can remember one particular place had a two-player black and white racing game (it was Sprint 2) and it had a faulty coin door – every time you put your 10p in, it would drop out the bottom straight into the turn-ups on my school trousers.

I often wondered what those turn-ups were for. We must have reused that 10p a hundred times that day.

### Why do you think shoot-'em-ups were so popular in arcades?

Back in the Seventies I think it had a lot to do with how the world was going through a space race and Cold War arms race. Every commercial electronic gadget got branded as a by-product of 'space-age technology' whether it be calculators, digital watches or computer games.

Whilst Atari's Lunar Lander was a classic directly related to the moon-landing main-frame games of the Sixties, we also had UFOs and 'little green men' served up with everything. These would often appear as slimy blobs in Star Trek, or ones with breathing problems like Darth Vader in the first epic Star Wars, and nasty ones like the face-suckers in Alien. Then there was Close Encounters, Space 1999, Silent Running, and even daft stuff like Moonraker.

Basically, a lot of early games featured 'you' as the saviour of the human race, protecting the home planet from an alien onslaught, and I think this appeals to a subconscious human need to survive.

### Why do you think that arcades were so successful?

It's hard to pinpoint one reason, but the fact is we like to play games – always have, always will.

What arcades did was provide a major new medium with which to immerse the player, giving them eye-candy explosions, survivable collisions,

sound effects and unique controls that could take a lot of more grief than any home console joystick, all in exchange for 10p. It was quite the fix back then.

### What do you think was the cause of the death of the arcade?

There were many reasons, including oversupply, too many clone games of mediocre quality, the arrival of endless bland interchangeable JAMMA game boards that fitted into unified arcade cabinets instead of all the unique cab designs that flourished in [the] late Seventies. There was also the fast-growing home video console market

and home computers that would often have adapted versions of what was in the arcades, although rarely as good.

### What's your favourite arcade game and why?

I can't really name one all-time favourite, but the ones I still like playing a lot would be Robotron, Missile Command, Asteroids, Space Invaders and Tempest. However, I also have other types of Eighties machines such as Taito's 'Ice-Cold-Beer' which might be electromechanical ball-bearing games, but are immensely addictive to anyone who attempts to play them.

### Tell us a little about your impressive coin-op collection.

The earliest cab – a Streets Defender – was bought around 1985, followed by a UK Robotron which I still own and is still working on its original board sets.

About 13-14 years ago I decided to sell the Streets Defender as I wanted to hunt down a real Williams Defender. Google and eBay were just happening, and I was amazed at how the price of collectable arcade cabs had gone through the roof and started to look around at ways of acquiring loads more. I ended up building good relations with numerous American collectors, courtesy of internet forums and in the following

few years I imported a few containers' worth of cabs from the USA as they were so much cheaper at the time, and also in much better condition than the damp rotten ones often found abandoned in damp UK garages after years of abuse. So began my interest in restoring my machines to near mint, reproducing all the artwork and other parts to make them look better than when they came out the factory 35 years ago. But that's a personal choice thing, as other collectors like to keep them grungy, smelling nice, with beer stains and fag burns.

In a way I was paying homage to the machines that inspired me to write games in the first place, and I have subsequently got to meet a lot of the original people behind those original machines, including Ed Logg, Eugene Jarvis and even The Creator himself once – Nolan Bushnell!

### Are you still actively restoring machines? Which was the last one you did?

Yes, but not as much as I used to. See the picture of a Space Invaders cocktail table machine that is now in sparkling condition. I think I've done those aliens proud with that one!

I still enjoy recreating precision side-art prints, the most recent being Battlezone and a rare Vectorbeam game called Speed-Freak. ★



Archer's collection is well stocked with classic games of the Seventies and Eighties.



The Missile Command cabinet seen here was featured as a restoration project in an early issue of Retro Gamer.

# ONE VISION

## A MICROVISION RETROSPECTIVE

Often billed as the first handheld game console, the Microvision is actually an evolutionary step in handheld electronic games, those distant cousins to videogames. Marty Goldberg reveals the history behind this pioneering product

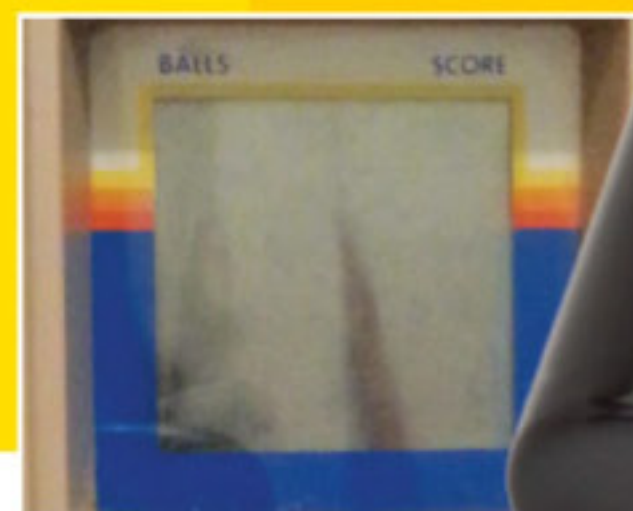

**E**lectronic gaming in the palm of your hand has been around almost as long as videogames. While the latter required a TV, the former arose in the mid-1970s as a way to use up excess calculator parts gathering dust in a market recently taken over

by the Japanese. The class of games was created in the US by Mattel after exec Mike Katz saw a new opportunity for those stagnant parts by repurposing them to play games on. Assigning some engineers to the project, they came up with a novel way of using microcontrollers (a small single-chip computer) with on-board game code to drive an LED display and the Mattel Electronics group was born. Comprising nothing more than glowing LED segments housed in patterned plastic, they were a far cry from actual videogames, but these small electronic games caught the imagination of a generation of children.

As other companies began to enter the market, a funny thing had happened by 1978: in the US, sales of electronic games actually outsold home videogames. In fact, while the magazine *Newsweek* was celebrating the high-tech toys and games on its cover that Christmas, home videogame sales were hit hard.

Additionally, a display shift had been brewing in the calculator market as LED-based calculators gave way to both vacuum fluorescent display (VFD) technologies – with crisp, glowing elements – and liquid crystal displays (LCD) offering lower power consumption.

“ [The chemicals] speed determined how many lines you could have in the display ”

Jay Smith recalls the problems with LCD screens

The stage was further set by the appearance of the handheld Merlin that year. Designed by Bob Doyle, this handheld electronic game was released by Parker Bros and went head to head with Milton Bradley's tabletop format Simon (designed by the legendary Ralph Baer) that Christmas season. Merlin's big advantage? It could play more than one game – switchable to several different built-in games, much like the dedicated videogame consoles of the mid-1970s.

It was during this backdrop of portable electronic dominance that the next generation of these handheld games were being designed at a small firm in Santa Monica, CA called Western Technologies. Jay Smith had founded Western Technologies on 19 September 1978 as an engineering firm to design electronic games and toys for the major toy companies of the era. A 'toy think tank' of sorts. Jay had come up with the concept of what became the Microvision thanks to a small side business of the company. "We were creating the chemicals that went into an LCD display and were selling them to Hughes Aircraft, a major manufacturer of LCD displays at the time," says Jay.

At the time, LCD displays were limited to a three-row display. As Jay illuminates, "Depending on the make-up of the chemicals, their speed determined how many lines you could have in the display. In



Sea Duel is essentially a one-player version of Milton Bradley's popular board game, Battleship. It's certainly worth seeking out.

“ We created a display system that only governed the rows being addressed ”

Jay Smith on how they solved the LCD issue

Connect Four. Following Mattel's lead, it tentatively stepped into the electronic toy and game market in 1977 with the tabletop Comp IV (released in the UK as Logic 5). A number sequencing game that was more an educational toy in the same class as Texas Instruments' Little Professor, it comprised a series of LEDs housed in a case meant to look like a child's version of a computer. It was joined that year by an updated electronic version of its classic board game Battleship. In 1978 Milton Bradley followed up with a new electronic board game called Laser Attack, a futuristic Star Wars-influenced electronic toy space fighter called Star Bird, and the aforementioned Simon. It was Simon, though, that Milton Bradley knew it had a hit with, and so it pulled out all the stops for its introduction. The game of glowing coloured lights and musical tones made its debut at New York's own location for dancing lights and musical sensations, the iconic Studio 54. When Jay approached Milton Bradley with the concept for his handheld electronic game with switchable games, the firm knew it had an appropriate follow-up to Simon.

The designers of the system – Jay Smith, Gerald Karr and Lawrence Jones – were awarded US patent number 4359222 for the Microvision. Entitled 'Handheld electronic game playing device with replaceable cartridges', it was originally filed on 30 October 1978.

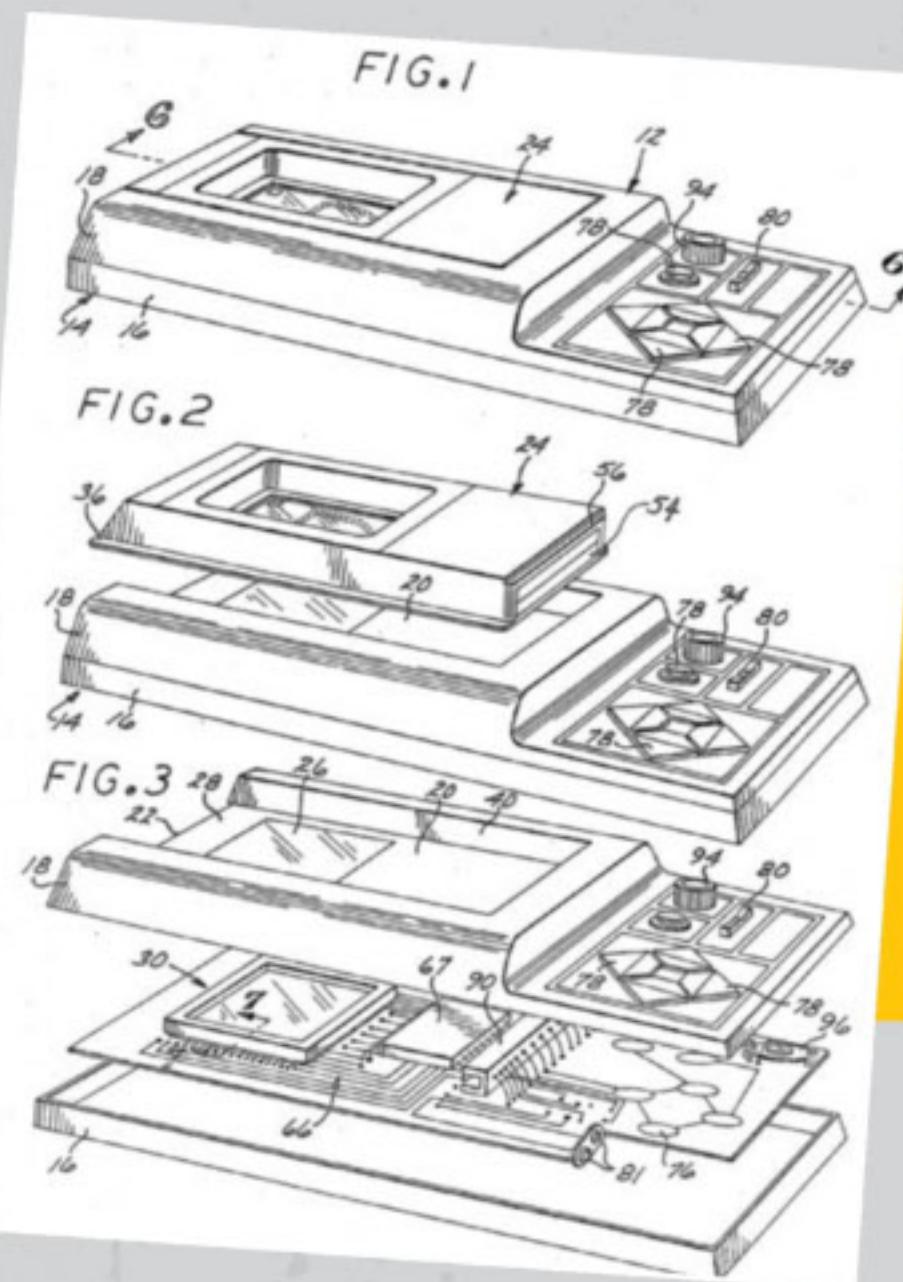

Described as a "A compact hand holdable electrical toy game assembly", the drawings show the initial proposed format for the Microvision which included both a primordial version of a 'd-pad' thumb controller and a spinner for playing paddle-style games. An alternate version shown in the same filing is a little closer to what became the actual Microvision, including a 12-button keypad, spinner and removable faceplate.

The development, from concept to full product, led to some interesting design work and changes from the initial concept. At first glance, the Microvision looks like an oblong version of the typical handheld electronic game of the time. This certainly wasn't needed for the electronics, as they take up about the same space (if not less) as the other games on the market. According to Jay Smith, the primary reason for all the extra space fell on Milton Bradley. Its reasoning being that the projected price would dictate the need for a larger size, as if the consumer would not understand they were paying for higher technology.

The main unit itself houses the LCD, its special controller chip, the controls and the connection to the system bus that works similarly to a cartridge slot. It's used for nothing more than I/O and power (Tiger's R-Zone handheld in the Nineties is similar in construct, but with an LCD contained on the removable portion). The most interesting addition, though, which shows a lot of insight into its replayability potential, is the control pad. Instead of a defined keypad with raised buttons (as shown in the concept drawings) it features a flattened pad, allowing it to be defined as needed by the faceplate. Combined with the spinner control, it provides custom control options on a per-game basis. A feature not matched until touch-based games proliferated on smartphones and tablet devices.

The microcontroller initially chosen by Jay and company was the Intel 8021, an 8-bit microcontroller

in the same family as the 8048 processor used in Magnavox's Odyssey2 console (Philips Videopac series) and introduced in 1976. With 64 bytes of RAM and able to address a game up to 1K in size (the typical game size up to that point had been about half that), it held enough resources to get the job done. Interestingly though, the 8021 has a higher power requirement than the typical microcontroller used in these devices and, combined with the requirements of the LCD, it made the Microvision require two 9V batteries (which added to the size of the unit as well). The 8021 was replaced with the Texas Instruments TMS1100 not long into the system's lifetime, however, thanks to some ordering issues for the Intel chip. A 4-bit microcontroller that's part of the TMS1000 series introduced in 1974, the 1100 has less RAM and processing power but can address up to 2K in ROM space. The other plus it brought was the lower power requirement, allowing the Microvision to need only one 9V battery now. Milton Bradley responded to

general, three rows was about it." Realising that three rows of dots was not enough to do a meaningful game display, he came up with a novel idea akin to how today's 3D graphics engines 'clip' graphic elements not being used in order to save processing speed. "We realised the graphic displays at the time counted every pixel every minute, whereas in a game display we would only use about 20% of the pixels at a time. Why worry about rows not being used? So we created a display system that only governed the rows being addressed." In this method, pixel rows that are on most of the time and static require the least amount of attention. Rows with semi-moving objects require a little more, and rows with regularly moving objects (a shot, a ball etc) require the most. This advancement allowed a formerly unheard of 16 rows of pixels and in turn created an LCD display that was much more viable for playing games on.

Having to come up with a custom LCD driver chip, the thought became that if they were advancing the technology this much display-wise they might as well make it a programmable system that could swap out cartridges. The problem was, once again, the technology (and cost) wasn't there yet to support a full microprocessor with swappable game ROMs in a handheld format.

Most LED handheld games of the time (and electronic toys in general) used what are called microcontrollers. A microcontroller is a chip that is essentially a full 'computer' on a single chip. That means the processor, RAM, input/output and other related technologies that are all separate in a traditional computer are combined in a single chip. Now, that chip and its resources were nowhere near as powerful and plentiful as a regular microprocessor-driven system at the time, but they weren't intended to be. Microcontrollers were created to be used in small, compact devices. Devices such as... you guessed it, calculators. That's one of the reasons why Mattel's first handheld electronic game (Auto Race) uses a microcontroller and the technology became a staple

of the handheld electronic games industry and the electronic toy industry as well.

The actual software that was to run on the microcontroller was usually packaged within the microcontroller IC itself in ROM format, further adding to the compactness of the device. However, just like all the other resources in the microcontroller, this meant you had a very limited amount of ROM space to work with. The programmer of Mattel's Auto Race, Mark Lesser, had to fit the entire game (logic, scoring etc) into 512 bytes of code. A feat that makes the typical 2K available to Atari 2600 game developers of the time seem spacious.

Jay Smith's solution was to leverage microcontrollers in a way not unlike dedicated videogame console manufacturers had looked at that year with their single-chip 'Pong-on-a-chip' based systems: create the illusion of switching out games by switching out the dedicated systems themselves. In that format, the system is really just the controller and display mechanism and the 'guts' are all on the part being swapped out. Companies in Europe like Hanimex had started releasing SD 050-based consoles in 1977 that did just that, and Atari had its Game Brain it showed at the summer '78 CES but chose not to release. In the case of Jay Smith's proposed device, the handheld unit would only contain the electronics for the LCD and controls. The microcontroller that contained the system's main circuitry and game itself would be located on a portion of the unit that would swap in and out, plugging into the other circuitry when it was docked.

Building a prototype, Jay Smith shopped it around and Milton Bradley wound up biting at the opportunity. Milton Bradley had started in 1860 as a board game company located in Springfield, Massachusetts. By the early 1970s, it had released board and novelty game titles that had become staples of many a person's youth, such as Mouse Trap, Operation, Battleship and

## INSIDE THE MICROVISION

Due to its rarity, it's not often you get to see inside this handheld

### CASE

Here's what's holding the Microvision together. It's worth noting that the bottom half of each front faceplate is typically different for each game. Connect 4, for example, has six control points while Block Buster only uses four.

### CONTRAST KNOB

A feature rarely seen on even later LCD-based handhelds, this enables the Microvision owner to adjust the contrast of the display – important considering it's not backlit.

### BATTERY STORAGE

The original Microvision needed 9V batteries. Changes during the production run lowered power requirements. The second slot became extra battery 'storage'.

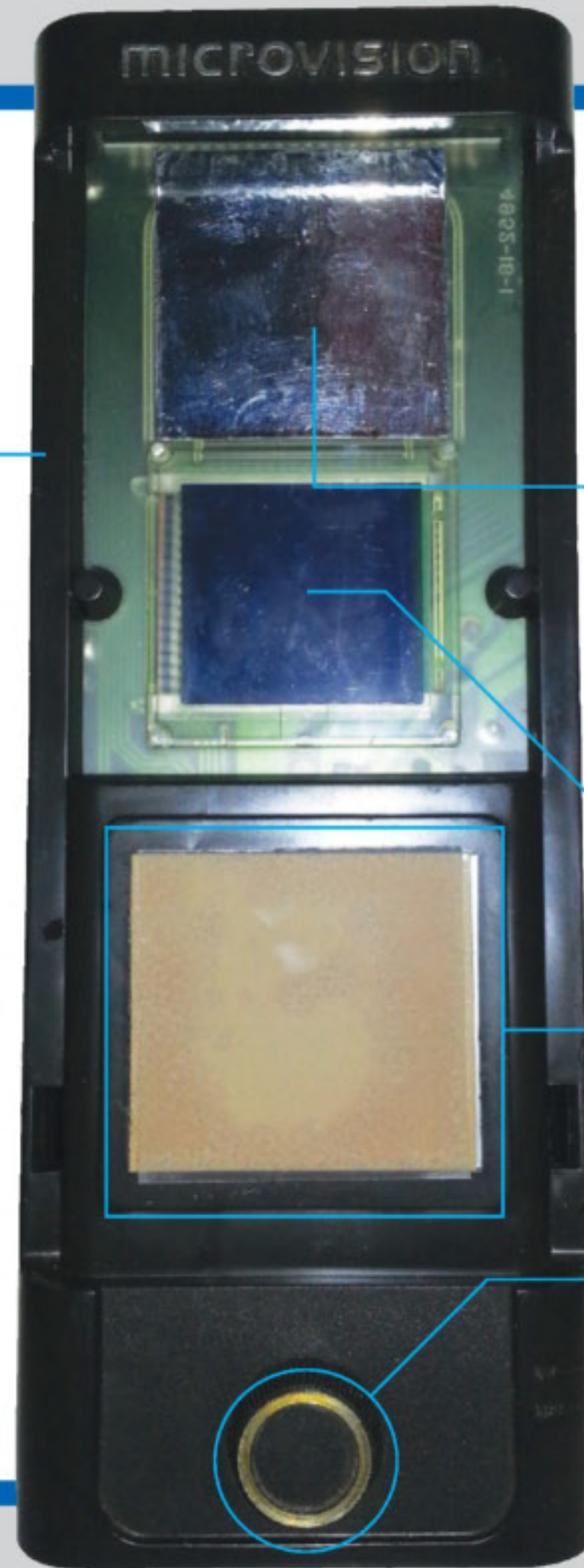

### LCD CONTROLLER

The custom controller chip for driving the then groundbreaking LCD. Commonly covered with a wound copper-backed foil sticker to protect from static discharge.

### CARTRIDGE SLOT

This is where you can attach new cartridges for your handheld. In total just 12 different games were created for the machine, making it an interesting challenge for collectors.

### LCD

Custom 16x16 LCD display designed by Jay Smith and his team. Unfortunately, because of early manufacturing limitations, it's prone to breakdown and a condition known as screen rot.

### TOUCHPAD (12 KEY)

12-key touchpad which has its areas defined by the faceplate. Technically similar to number pads on console controllers like Intellivision and Colecovision.



### PADDLE

The Microvision's mounted spinner control. Its functions differ on a per-game basis and include everything from a traditional paddle control to adjusting range settings.



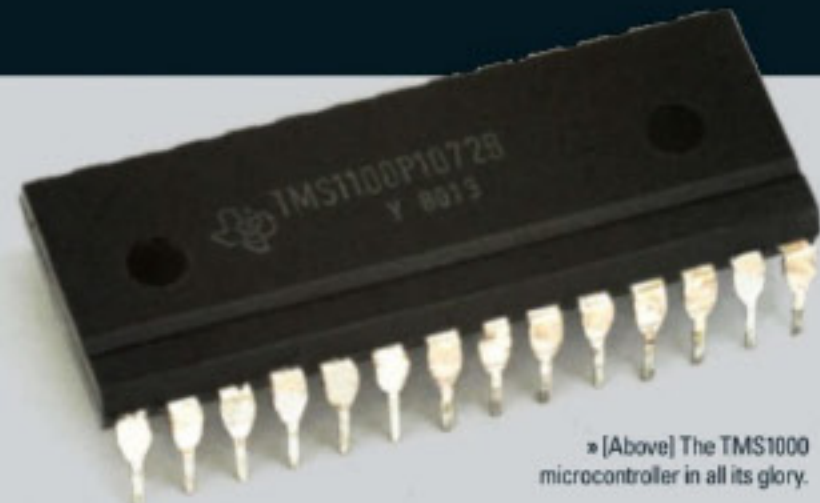

► [Above] The TMS1100 microcontroller in all its glory.

► [Right] Funnily enough, *Block Buster* is Milton Bradley's take on the arcade hit *Breakout*.

► the dropping of one battery by leaving in the extra battery port instead of redoing the system moulds, simply unwiring it. The old battery port was now redubbed as "extra battery storage". They couldn't escape the need to recode the software for the games, however, for the more primitive TMS1100.

The microcontroller, as mentioned, is housed in a removable faceplate. Each faceplate is designed to give a custom experience to the game, not unlike the elements of an arcade game. The game's name is provided in a unique and colourful 'marquee' and the screen bezel contains colourful surrounding graphics and sometimes overlaid markings relevant to the gameplay. Finally there's the control area. Using a combination of moulded plastic to 'expose' the relevant spots on the touch pad and coloured text or graphics that describe the button's function, the control customisation available for each game was unparalleled. On the reverse side of the panel is what looks like a 'dust protector' similar to the Atari 2600



protectors; however, that's not its function. While the problem of static discharge on the exposed contacts was solved in videogame consoles, it was a major issue for the Microvision. One wrong touch and 'poof' it would go, wiping out the game and microcontroller. The cover that flips off to expose the contact was meant to protect it from this mishap.

**T**he Microvision was released in November 1979 for around \$40 along with another high-tech toy offering by Milton Bradley, the programmable Big

Trak. It came with the *Breakout* clone *Block Buster* along with three available launch titles: *Bowling*, *Connect Four* (a version of Milton Bradley's popular 1974 board game) and *Pinball*.

The Microvision was of course not the only next-generation electronic game to hit the market in 1979 with an advanced display, as toy manufacturer MEGO (famous maker of superhero toy dolls and dolls based on movies like *Planet of the Apes*) came out with the Mini-Vid series of tabletop two-player games. Featuring a 16x20 VFD display, it came in versions for four different games: *Break Free*, *Dodge City Gunfight*, *Sea Battle*, and *Spacewar*. In fact, 1979 turned out to be the year of the two-player handheld electronic game: Coleco had the 'Head to Head' series of tabletop sports games, while Pulsonic released its classic two-player *Baseball* game.

While the ability for two players (one on each end of the unit) to play head to head was certainly an advantage, you still had to buy four separate units. Though Microvision was only one-player, the

advantage of being able to play different games on the unit outweighed that fact for parents. Likewise, the appearance of the Microvision disproved the statement by Dick Dalessio, Parker Brothers' director of product planning, who revealed in the December 1979 issue of *Popular Science* that: "The electronics are basically the same as last year, but the programming makes them entirely new." Although that was certainly true in relation to the expected updates to already popular Football and Basketball games by Mattel and Coleco, and the onslaught of Simon competitors.

The Microvision was a big success that first year, and according to some reports earned \$8 million in revenue. Over the next two years the library expanded to include *Mindbuster*, *Baseball*, *Sea Duel*, *Alien Raiders*, *Cosmic Hunters* and the licensed *Star Trek: Phaser Strike*. However, beyond that initial year the sales continued to steadily decline. Thanks to the runaway success of Atari's release of *Space Invaders* for its VCS console, the problem was that actual videogame consoles were fast becoming king again in 1980. The entire handheld electronic game market started dropping drastically and was relegated to a

rarity of working models. Because of the 'primitive' manufacturing methods behind the groundbreaking LCD display, they are highly susceptible to temperature changes. The chemicals in the display are also prone to leakage, a condition known as 'screen rot' that eventually destroys the display.

Milton Bradley released a European version as well (which came with its own vinyl slip-on cover), along with European versions of the US games plus one exclusive: *Super Block Buster*. The Microvision might not have been the huge enduring success that Milton Bradley was hoping for, but it remains an important footnote in gaming's rich history. ★

Special Thanks to Scott Schreiber, Benj Edwards and Dan Boris



## INSIDE THE FACEPLATE/ CARTRIDGE

Each faceplate actually houses the main electronics of the unit and plugs in like a cartridge

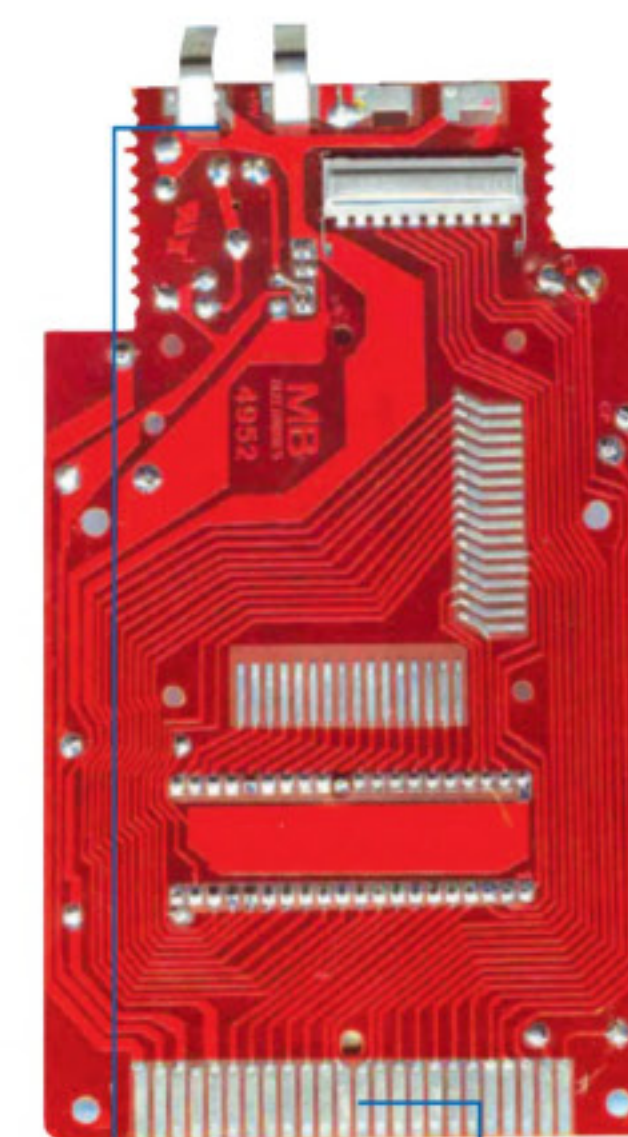

### BATTERY CONNECTOR

■ These leaf terminals connect to the battery when the faceplate is plugged in, providing power to the microcontroller.

### SYSTEM BUS CONNECTOR

■ The part of the faceplate that plugs into the main unit, these edge connectors provide the microcontroller with access to the controls and display.

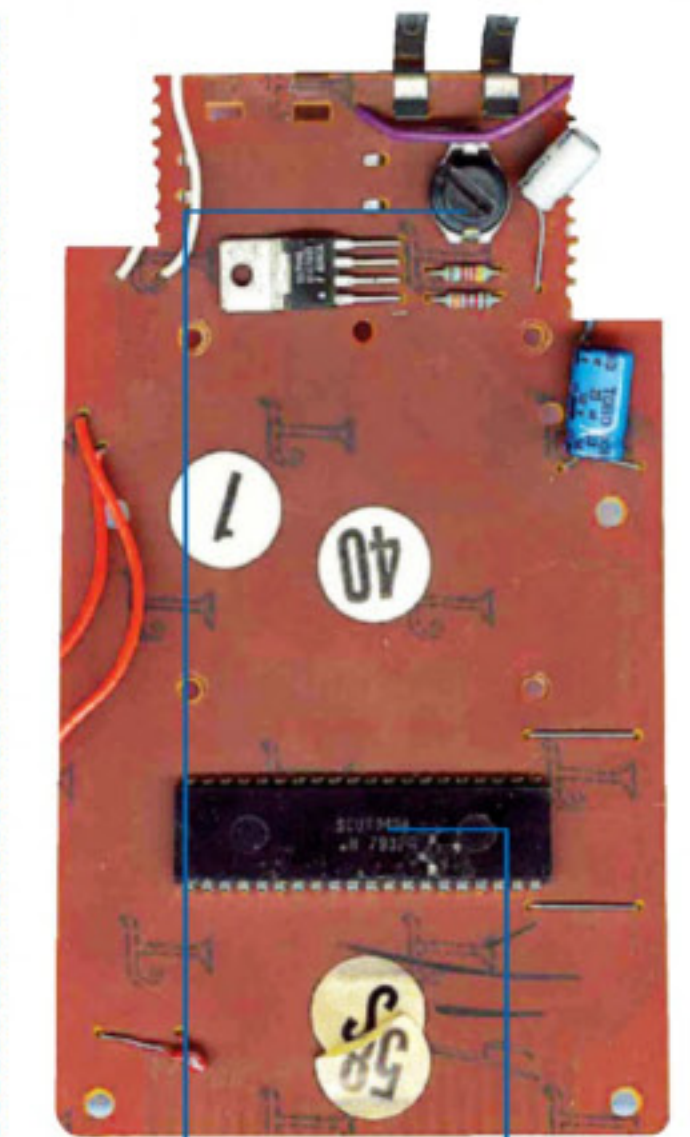

### CONTRAST KNOB

■ Being able to change the brightness of your screen when there's no available backlight is always handy. Needless to say, you'd often be fiddling with this quite a lot while playing.

### GAME CODE

■ The all-in-one microcontroller that includes the game ROM code as well. Originally based on the Intel 8021 and later replaced with the TMS1100.

|| A compact hand holdable electrical toy game assembly ||

The Microvision's US patent description

cheap portable gaming accessory for much of the 1980s until Nintendo released the first actual handheld console in 1989, its monochrome LCD-driven Game Boy (followed shortly after by Atari Corp's full-colour LCD Lynx handheld console). Milton Bradley stopped manufacturing the Microvision in the US in 1981 and dropped it in Europe in 1982.

Jay Smith had actually proposed two updates to the Microvision – one with a larger display and another with a colour LCD – but Milton Bradley declined, feeling the format had run its course. Not one to rest on his laurels, Jay Smith did move on to create an LCD game watch for manufacturer GCE and then the equally innovative vector gaming console the Vectrex. Milton Bradley wound up picking up the latter for European distribution, and Smith even looked at doing a portable version of the Vectrex in the late Eighties that never panned out.

Microvisions are actually extremely collectable items today, not as much for their uniqueness but for the

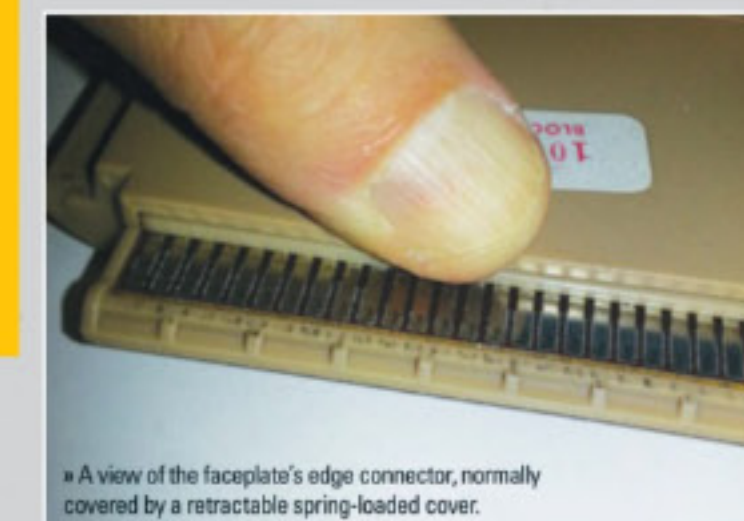

► A view of the faceplate's edge connector, normally covered by a retractable spring-loaded cover.

## ESSENTIAL GAMES

If you do find a working machine, play these

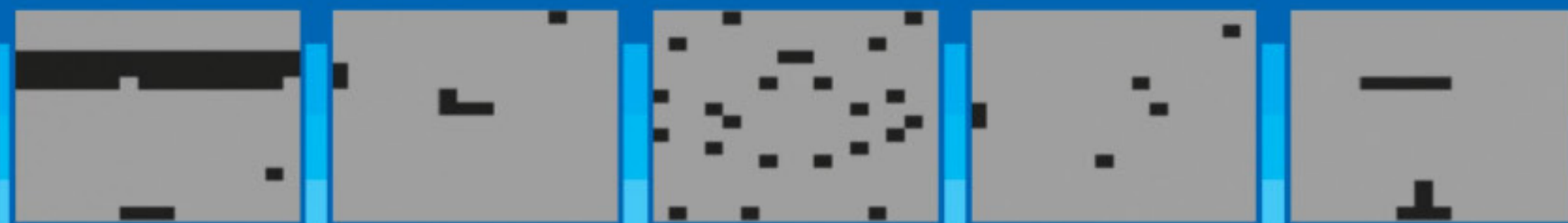

### BLOCK BUSTER

■ Use the console's built-in paddle to hit the ball and knock away bricks. What else can really be said of this pedestrian *Breakout* clone? What really makes it a notch above the rest isn't the version of the game itself, but the fact you can use an actual spinner to control the on-screen paddle. Digital thumb pads and analogue joysticks found on regular handheld videogame consoles two decades later just don't cut it for accurate control of the paddle. You need a spinner for the proper timing and feedback needed to enjoy paddle games and the Microvision has it!

### SEA DUEL

■ A one-player version of Milton Bradley's *Battleship* board game. In fact, many of the games on the Microvision were versions of MB board games and toys (much to the dismay of Jay Smith who wanted to expand beyond those offerings). Here, a destroyer is pitted against a submarine with an emphasis on tactics. Designed for two players, both opponents separately 'program' their movements and fire shots ahead of time, then watch the game execute them. It plays similar to some of the American Football slideshow games of the early '70s.

### COSMIC HUNTER

■ In this space game you're hunting alien creatures while avoiding barriers, hidden traps, and being captured by said aliens. You only get five hunters and once they're all captured, your game is over. By the same token, you get to capture as many aliens as your hunting heart desires. A fun little game combining shooter and strategy mechanics. *Cosmic Hunter* is notable for providing the earliest instance of a D-pad (directional pad) in a game, a control Gunpei Yokoi used to great effect on Nintendo's Game & Watch games starting in 1982.

### ALIEN RAIDERS

■ A *Space Invaders* clone, it's just different enough to avoid any legal issues. Horizontally orientated, 'aliens' race across the screen from right to left and try to reach your side of the screen. They don't fire, they just try to get at you before you can shoot them. With gameplay that's more of a cross between *Space Invaders* and *Midway's* then recently released arcade game *Space Zap*, your only recourse is to fire at them from one of three pre-ordained spots with a variable-length laser beam (whose length is decided by the system's spinner).

### STAR TREK: PHASER STRIKE

■ The only licensed game on the Microvision, it was developed as a tie-in to the then new *Star Trek: The Motion Picture*. By the time of its European release, however, the *Star Trek* licence was dropped and the game was renamed *Phaser Strike*. The premise is what you'd expect for a *Star Trek* game: shoot Klingons. It plays a lot like Atari's *Missile Command* meets *Midway's Sea Wolf*. As the Klingons fly horizontally across the screen, you get to shoot at them from any one of three phaser banks.

## CLASSIC MOMENTS

# Contra: Hard Corps

PLATFORM: MEGA DRIVE • DEVELOPER: KONAMI • RELEASED: 1994

**K**onami seemed unstoppable in the 16-bit days, churning out endlessly inventive games that would often push the host hardware to its limits. This thrilling battle from its only Mega Drive *Contra* game is a perfect example of the creativity and imagination that was flowing from the Japanese studio during the Nineties. It's a fantastic skirmish from level two that sees you attempting to bring an enemy to justice. Sadly, he's placed himself in a gigantic mech suit that stomps around in the distance, trying to hit you with projectiles and its arms, before running forward and attempting to squish you underfoot. It's not only an amazingly memorable moment, from a game packed full of memorable moments, but also shows just how technically proficient Konami was. Little wonder Treasure got off to such an amazing start. ★

## BIO

Some corners of the internet whisper that Konami's one and only Mega Drive *Contra* game is actually better than *Contra III*. It's a fair conclusion to come to, thanks to *Hard Corps*'s insane, breakneck pace, inventive and eclectic bosses and the same sort of breathtaking aesthetics that would appear in future Treasure games. While the control system is arguably weaker than the one found in *Contra III*, the branching levels and flowing narration make for one of the best games in the series.

## MORE CLASSIC CONTRA: HARD CORPS MOMENTS



### "You shall not pass!"

One of the freakiest bosses is found on a late jungle stage. As you begin to cross a bridge, a shadowy form appears behind the waterfall. Two huge clawed hands then appear and grab your walkway, shaking it violently. While you can't be dislodged, it does make it incredibly tricky to fire off accurate shots into the boss's ugly insectoid face.



### Enter, Soundwave

You're not even halfway through the first level when this giant boss appears. First seen as a monstrous figure stomping in the background, it suddenly leaps in front of you, filling the screen! Konami uses clever sprite-splitting techniques to impress, while keeping you busy by having the metallic terror assault you by flinging cars and summoning massive jets of flame.



### Motorcycle madness

At the start of stage three you find yourself in a barren wasteland. Tiny sprites race down the mountains in the distance and you struggle to make out what they are. Then, motorbikes suddenly spring onto the screen, ready to run you over. As you see more bikes appear in the background, panic builds as you wonder if you'll be able to take them all down.



### It's morphing time!

After catching up with a wanted hacker, he sends you into a virtual world he's created. It's a vicious place, filled with deadly constellations of bulls and archers, but worse awaits you. At the halfway point, your adversary morphs into a series of squares that spit out *Tetris*-shaped blocks, before transforming into a deadly tank and helicopter combo. Eep!

# MAD PLANETS

Mad Planets should really be up there with Defender, Asteroids and Tempest on a list of classic arcade shooters, but sadly it never got the recognition it deserved. Mike Bevan speaks to Jeff Lee and Kan Yabumoto about Gottlieb's cult interstellar blaster

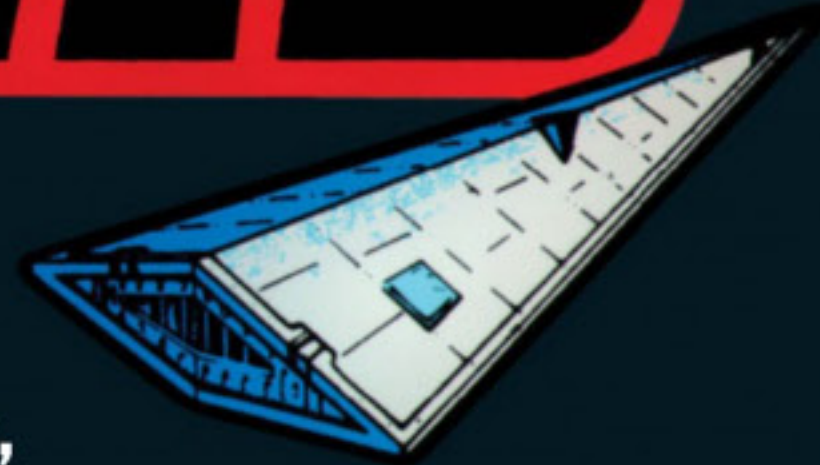

part *Asteroids* – and, like the latter, it's an acute exercise in controlling chaos. Against an imposing animated starfield, planets appear in the distance, and rush into view. They're harmless at first so it's best to dispatch them before they grow in size and start chasing you around the screen, moving in increasingly rapid elliptical patterns that make them progressively harder to hit. For some reason, these planets are pretty mad at you. Not only that, they carry little orbiting moons that occasionally split off and start attacking your ship. You need to shoot all the moons before you can start dispatching the planets themselves, and there can be



up to five planets on screen, which in turn can have up to six satellites in orbit around them. Coupled with the occasional errant comet and the little astronauts floating about in need of rescue, it adds up to quite a challenge as you try to make it through the game's 32 rounds without being mashed between rampaging astronomical bodies.

The orbiting moons, which rotate around the larger planets and cast

tiny shadows on their surface, are a distinctive feature of *Mad Planets* and predate the idea for the actual game. Gottlieb programmer Kan Yabumoto had been working on a project that displayed a series of vertical 3D cubes on the firm's arcade hardware. Inspired by a graphics demo that Jeff had produced on an Apple computer, this idea would later resurface in *Q\*bert*. After working on the cube display for a few weeks, Gottlieb's vice-president of engineering, Ron Waxman shifted him to another project, assisting arcade hardware designer Jun Yum. "Jun insisted on something which showed the power of his hardware," Kan recalls, "where little satellites came in front of and disappeared to the back of a planet."



“I remember making a model and taking Polaroid photos to ‘rotoscope’ the ship for the spinning effect”

Jeff Lee on animating the main sprite

After the *Q\*bert* project was given to Warren Davis to complete, Kan was asked if he might be able to produce a game based on the 'planet thing'. "We did not have a game, only some preliminary rotating satellites," admits Kan. "I knew the cube thing had more potential. From a programmer's point of view, a

*Q\*bert*-like game was much easier to write. The idea was everything. *Mad Planets* did not have a 'game idea' until the very end." Jeff Lee was brought on board to help Kan out with the graphics while also designing *Q\*bert*'s colourful characters. "I was probably working on both simultaneously because I was producing graphics for all of the videogames in the pipeline except Tim Skelly's games and licensed products," he tells us. For Kan and Jeff, turning



**IN THE KNOW**  
 PUBLISHER: GOTTLIEB  
 DEVELOPER: IN-HOUSE  
 RELEASED: 1983  
 PLATFORM: ARCADE  
 GENRE: SHOOT-'EM-UP

Many people will never have actually played *Mad Planets*, at least not in its original arcade format. But readers of a certain age may well find the screenshots on these pages familiar. The game was released by American coin-op maker Gottlieb in 1983, just months after its much more famous arcade title *Q\*bert*. Artist Jeff Lee, creator of the *Q\*bert* character, was also behind the graphics for *Mad Planets*. And although not nearly as well distributed throughout the arcade world, it was encountered by a Brighton-based programmer, Simon Nicol, who used the game as the basis for a much-loved C64 shoot-'em-up, *Crazy Comets*.

In *Mad Planets* the whole universe is out to kill you. It's a curious and finely tuned hybrid – part *Defender*,



[Arcade] A large six-mooned planet and a smaller one sending its satellite to attack the ship.



[Arcade] The 'enemy' planets graded in order of size and angeriness...

## CRAZY COMETS

Simon Nicol recalls how *Mad Planets* inspired him to make his C64 clone

"The only *Mad Planets* arcade machine I ever saw was in Brighton's Western Road, in a place called Regency Leisure," says Simon Nicol, author of *Crazy Comets*, the unofficial version of the game best known on the C64. "Between you, me and the gatepost, I was bunking off school..." Written when Simon was just 16, *Crazy Comets* was his first commercial game and a remarkably authentic effort, in some ways bettering the original with its improved starfield and Rob Hubbard's superb music. He followed it with a sequel, *Mega Apocalypse*, which added speech and co-op play, before producing a SNES version, *Apocalypse II* for Psygnosis. Although the latter was never released, an official cartridge version is finally about to be made available (from [www.pikointeractive.com](http://www.pikointeractive.com)). Simon also has a more modern update of his most well-known game up his sleeve. "I'm currently developing a new version of *Comets* for the PlayStation Vita," he reveals, "so keep your eyes peeled next year for its release..."



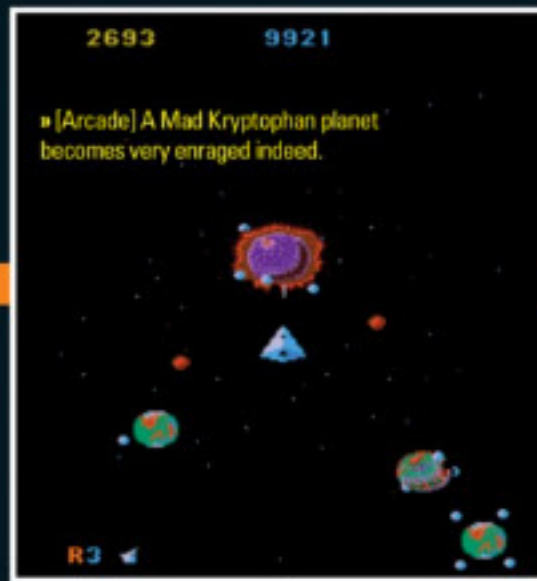

Detail of the eye-catching arcade cabinet. (Photo © Bill Johnston)

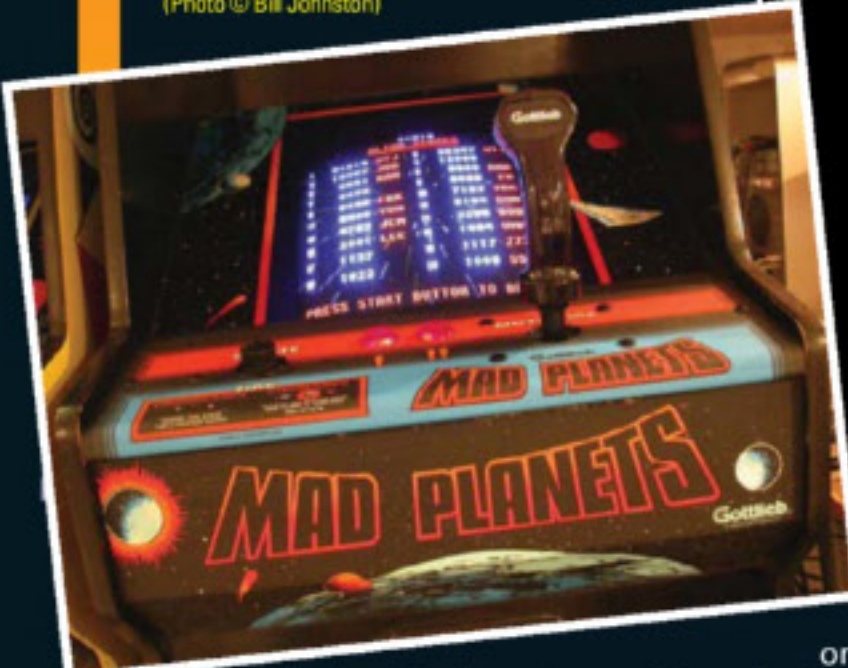

"The whole game was written in the 8086 assembler in 24KB," says Kan. "The background star animation was table-driven. The table was pre-computed on my home computer in BASIC. The twinkling effect was achieved by occasionally substituting the coloured pixels with a blank character during the game cycle." Kan's program pushed the arcade hardware to its limits, particularly as the game progressed and threw increasingly complex attack waves at the player. "The CPU for *Mad Planets* was a lot busier under the hood than *Q\*Bert's*," he reveals. "Every drop of machine cycle was treated as a precious resource. The motions of planets, moons and comets were not linear, and the program had to compute the positions of all moving objects on the screen in the busiest round (Round 32 with five planets with 25 moons, ten bullets, 200 stars, a comet and an erratic astronaut plus the ship)."



DEVELOPER HIGHLIGHTS

REACTOR

SYSTEM: ARCADE  
YEAR: 1982

Q\*BERT (PICTURED)

SYSTEM: ARCADE  
YEAR: 1982

EXTERMINATOR

SYSTEM: ARCADE  
YEAR: 1989

interesting challenge with only 16 colours," he says. "I had previously done cel animation and one job was of a spinning Earth. I got a globe and sketched out a pencil test, figuring out how many frames I needed for the allotted time... so this was a familiar type of assignment, except we didn't have frame rates, only constraints of memory and how many foreground sprites were available." *Mad Planets* used a fairly unique control system comprised of a spinner coupled with a joystick. The spinner allowed players to independently rotate the direction their ship was pointing, *Asteroids*-style, while controlling its lateral and vertical movement

with the joystick. This meant creating a series of sprite animations for the rotating ship as it moved through 360 degrees, something Jeff solved in a very practical way. "I remember making a model and taking Polaroid photos to 'rotoscope' the ship's positions onto graph paper and then into pixels for the spinning effect," he says. "I had to photograph the model at the desired stages and at proper scale, then trace with paper and pencil over the photos. I then transferred the shapes into a graphic utility for designing the sprites."

As Kan mentions, the movement of the attacking planets was not random, but governed by a complicated mathematical formula based on the real-life laws of

physics. "There was a 'rubber-band' effect between the planets and the starship, relative to the distance between them, a concept known as Hooke's Law," he explains. "The further from the ship, the stronger the attraction is. Therefore, when you finish the very last moon that belongs to a planet that happens to be at the farthest corner of the screen, the planet comes straight at you at a surprising speed. I also wanted to make sure the game played fairly. For example, when the starship was on the right-hand side of the screen, a comet would always appear from the left-hand (opposite) side. The only thing I hated was the fact the *Mad Planets* 'universe' had 'edges' that bounced the planets even when it was red hot mad and fast."

"After we had the basic game, we spent weeks and months tweaking the parameters," Kan continues. "*Mad Planets* was written in such a way that plugging a few numbers into a master game control table changed the whole game dynamics. Until I played the game a lot, I did not know that you could 'swing' a planet by wiggling the ship and letting the planet orbit around you without hitting you. The comet was invented to kill a play trick like that. A lot of things in the game were not by design but a consequence

of formulas we chose. But the parameters we later plugged in were very carefully tweaked with hundreds of hours of playing. We kept saying it was fun but something was missing... Then, in the last month, the astronauts were added. Without them, there was no *Mad Planets*."

The astronauts floating around the screen are a good source of bonus points and potential extra lives, and form the basis of a special 'astronaut rescue' stage that occurs every few rounds. "In retrospect, the grouping of three or four rounds as a wave and the bonus period at the end of the group made a nice rhythm to the play. I think the helpless astronauts floating away from you at the perfect relative speed had a healthy dose of frustration. Some of those are pure accident. Someone

[Arcade] Destroying all planets in a wave before they grow large nets you a Perfect Round Bonus.



[Arcade] The comets were a last-minute addition to stop players taking advantage of on-screen safe spots.



remarked that *Mad Planets* had so much randomness in it. And, no two games were quite the same..."

"One thing that people should give credit is the sound effects," adds Kan. "Dave Thiel was responsible for the great sounds in *Mad Planets*. Listen to the comet sound, the harmonious Perfect Round fanfare, and the sound of your starship disintegrating, which is probably one of the best crushing sounds. These sounds were not recorded from real life; they were all synthesized from scratch." The final notable aspect of *Mad Planets* is the distinctive cabinet artwork, with its striking orange logo emblazoned across and below the

control panel. "The cabinet art was produced by Terry Doerzaph, with a lot of direction from Richard Tracy, our boss," says Jeff. "I did produce a prototype control panel which was screened onto Mylar, and elements were incorporated into the manual cover art."

Despite being such a striking and finely tuned game, *Mad Planets* was never going to eclipse its stablemate in the arcades. "*Q\*Bert* was probably the only game from the Gottlieb/Mylstar company that had received a fair recognition in the market," says Kan regretfully. "Unfortunately, Gottlieb had extremely weak sales and marketing resources and our deserving products went nowhere." Although Kan harbours a sense of disappointment about the coin-op's limited distribution, Jeff still displays a degree of satisfaction about the game. "Well... along with *Q\*Bert*, *Mad Planets* is included in *1001 Video Games To Play Before You Die*," he points out "They are the only two Gottlieb games that make that list. *Mad Planets* lacked a 'cute' hook, but it's a raucous shoot-'em-up, a totally different animal with some slightly bizarre touches, and a tough game, too. The game got positive reviews back in the day, but there were plenty of alien and space shooting games as competition. I am gratified if there is a 'cult' fan base." ★

Thanks to Kan Yabumoto, Jeff Lee, Simon Nicol and Bill Johnston at [www.chompingquarters.com](http://www.chompingquarters.com)

**"In the last month, the astronauts were added. Without them, there was no Mad Planets"**

Kan Yabumoto recalls the final piece of the jigsaw



The game manual featuring artwork by Jeff Lee.



PLANET BUSTERS Six games where you protect planets. Or blow them up...



DEFENDER

Eugene Jarvis's blisteringly complex arcade game is a life-or-death struggle against humanoid-abducting aliens and its multi-button control system. Let all the little men on the planet's surface get killed and the whole thing explodes, plunging you into space where the onslaught is faster and more terrifying than anything you've encountered so far.



MISSILE COMMAND

Atari's apocalyptic coin-op is an appropriate metaphor for the futility of nuclear war, as it's completely unwinnable. The best you can do is hold off the rain of enemy missiles as long as you can, until your cities succumb to the inevitable. And as the screen whites out, the infamous phrase "THIS IS THE END" indicates game over.



ASTRO CHASE

In the debut release from Boulderdash publisher First Star Software, you have to protect Earth from flying saucers which are launching Megamines at our home-world. These doomsday weapons are extremely nasty and if even one gets through, our planet goes boom in spectacular style, all to the jaunty strains of Tchaikovsky's *1812 Overture*.



CAPTAIN BLOOD

Infogrames' surreal Gallic space adventure puts you in the title role of a cosmic bounty-hunter trying to track down and kill a number of errant clones of himself. From the helm of his ship, the Ark, Captain Blood can visit various planets, interrogate alien species, launch probes over fractally generated worlds, or even disintegrate them entirely.

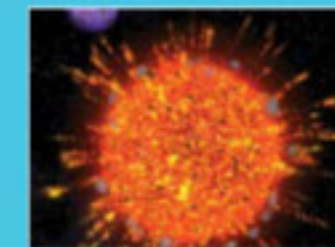

SPORE

In Will Wright's evolutionary simulation you progress from a tiny micro-organism to controlling a whole world. At this point the player can build the ultimate destructive weapon, the Planet Buster, breaking all manner of health and safety regulations in the process. However, locating and destroying the Earth is actually necessary for 100% completion of the game...



METEOS

This splendid intergalactic puzzle game was produced by Tetsuya Mizuguchi, designer of *Rez* and *Lumines*. With the evil planet Meteo sending meteors to crush opposing worlds, it's up to you dispatch them by aligning same-colour blocks to launch them into space. The ultimate aim is to reach Meteo and destroy the source of the meteors for good.

# SAVE OVER 50% ON A GIFT SUBSCRIPTION THIS CHRISTMAS\*

ON A GIFT SUBSCRIPTION THIS CHRISTMAS\*



**JUST £24.99**

12 ISSUES, SAVE 58%



**WORLD OF ANIMALS**  
Everything you need to know about the world's most amazing wildlife  
13 issues, save 52%



**HOW IT WORKS ILLUSTRATED**  
Travel-sized, fun learning for children aged 7-11  
6 issues, save 50%

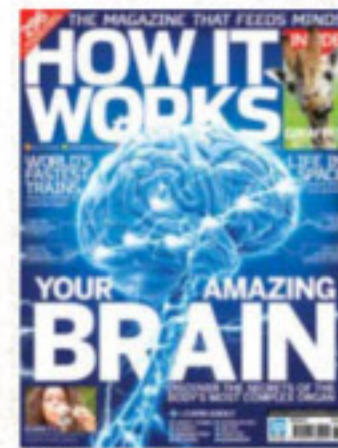

**HOW IT WORKS**  
The action-packed science and technology magazine  
13 issues, save 52%



**HISTORY OF WAR**  
The stories, strategies, heroes and machines of historic conflicts  
12 issues, save 58%



**DIGITAL PHOTOGRAPHER**  
Inspiration, tutorials and tools for enthusiasts and professionals  
12 issues, save 58%



**RETRO GAMER**  
The number one magazine for classic gaming  
12 issues, save 58%



**ALL ABOUT SPACE**  
Discover the wonders of the universe  
13 issues, save 52%



**SCIFINOW**  
The number one magazine for sci-fi, fantasy and horror fans  
12 issues, save 58%

## SUBSCRIBE TO ANY MAGAZINE FOR JUST £24.99

- \* Exclusive Christmas offer
- \* Save over 50% on the shop price\*
- \* Never miss an issue of your favourite magazine
- \* Free delivery, direct to your door
- \* Ideal Christmas gift - that lasts all year!
- \* Free e-card to send when you buy as a gift

## FIND MORE OF OUR GREAT TITLES AT THIS PRICE ONLINE



Order by 15<sup>th</sup> December to start your subscription the first issue after Christmas.

## BUY AS A GIFT OR TREAT YOURSELF!

Use code **XMAS141** for this extra-special price.

### BY POST

Send your completed form to:  
Imagine Subscriptions, 800 Guillat Avenue,  
Kent Science Park, Sittingbourne, Kent ME9 8GU

### YOUR DETAILS

Title \_\_\_\_\_ First name \_\_\_\_\_  
Surname \_\_\_\_\_  
Address \_\_\_\_\_  
\_\_\_\_\_  
Postcode \_\_\_\_\_ Country \_\_\_\_\_  
Telephone number \_\_\_\_\_  
Mobile number \_\_\_\_\_  
Email address \_\_\_\_\_  
This subscription is  for me  a gift

### DELIVERY DETAILS (IF DIFFERENT FROM ABOVE)

Title \_\_\_\_\_ First name \_\_\_\_\_  
Surname \_\_\_\_\_  
Address \_\_\_\_\_  
\_\_\_\_\_  
Postcode \_\_\_\_\_ Country \_\_\_\_\_  
Telephone number \_\_\_\_\_

### PAYMENT DETAILS

UK £24.99 Magazine name \_\_\_\_\_

FOR MULTIPLE ORDERS PLEASE CALL THE ORDER HOTLINE **0844 856 0644**

### CHEQUE

I enclose a cheque for £ \_\_\_\_\_  
(made payable to Imagine Publishing Ltd)

### CREDIT/DEBIT CARD

Visa  Mastercard  Amex  Maestro  
Card number                  
Expiry date      
Issue number (Maestro)

Signed \_\_\_\_\_

Date \_\_\_\_\_

All subscribers receive a monthly e-newsletter of news and offers.  
Please tick if you would prefer not to receive any promotional material from Imagine Publishing:

by post  by telephone  by email

Please tick if you would prefer not to receive any promotional material from other companies  
by post  by telephone  by email

Please tick if you DO wish to receive such information by email

### TERMS & CONDITIONS

\*How It Works Illustrated is a bimonthly magazine, priced at £21 for 6 issues, which is a 50% saving against the cover price. All other titles are priced at £24.99 saving over 50% on the shop price. For the full list of titles and issue details please visit [www.imaginesubs.co.uk/XMAS141](http://www.imaginesubs.co.uk/XMAS141). This is a UK-only offer, for overseas offers please visit [www.imaginesubs.co.uk/XMAS141](http://www.imaginesubs.co.uk/XMAS141) or call +44 (0)1795 592 869. Gift subscriptions ordered by 15th December will begin with the first issue on sale January 2015 – orders after this date will start with the following issue. You have the option of sending a digital gift card so please include your email address in the form above. Non-gift subscriptions will start with the next available issue. Offer ends 31st December 2014. Promo code XMAS141

ORDER HOTLINE 0844 856 0644

ONLINE AT [www.imaginesubs.co.uk/xmas141](http://www.imaginesubs.co.uk/xmas141)

# VOLGARR THE VIKING

Built upon the ideals of the classic side-scrolling beat-'em-ups of the 8- and 16-bit eras, *Volgarr The Viking* brings a very retro feel to a modern audience

DEVELOPER: CRAZY VIKING STUDIOS ■ SYSTEM: PC ■ GENRE: ACTION

**V**olgarr *The Viking* is tough. Really tough. Though its core mechanics don't take much to learn – really all you'll be pressing is Z and/or X – it's designed in such a way that you'll need repeated attempts before you properly understand how to overcome a situation. "The whole project started with this question," poses one of *Volgarr's* two developers Taron Millet: "Why is *Super Ghouls N' Ghosts* the only game we have ever seen that uses its unique jumping mechanic, where you have fixed jump arcs but a momentum-cancelling second jump? There was just so much cool stuff that could be done with that!"

The crux of *Volgarr* revolves around this particular mechanic, but takes much more of its inspiration's flavour, too. The clever undressing system – whereby the more damage you take, the more naked your hero becomes – is also implemented into *Volgarr*. As you explore you'll find chests, and within those you'll find staged upgrades; survive without taking a hit for longer and you'll earn a sturdier shield, greater armour or even a flaming sword. Combine this with a variety of enemies with simple attack patterns in increasingly challenging situations and you're left with a game designed to get you coming back to perfect your playthrough in spite of the challenge it sets. Despite that, it was never the plan – simply a happy accident, of sorts. "We didn't start out with difficulty as necessarily being the primary goal,"

says Taron, "but our inspirations were known as difficult games, so it seemed natural. Beyond that, we just find it frustrating how many games are designed more like movies than games – intending for everyone to get through it eventually, and trying to minimise replaying a section because that messes with the narrative."

Finding that perfect balance was the hardest part of the game's development. "There's not too much about it that's really technical," claims Kristofer Durrschmidt. "There's no special techniques that were used or anything." The reason *Volgarr* manages to recall its retro roots, says Kris, is due to the "countless hours researching, testing, and tweaking". According to Kris, his co-developer Taron "must have adjusted *Volgarr's* gravity and initial jump velocities a hundred times before we even built any real levels. Taron spent a whole

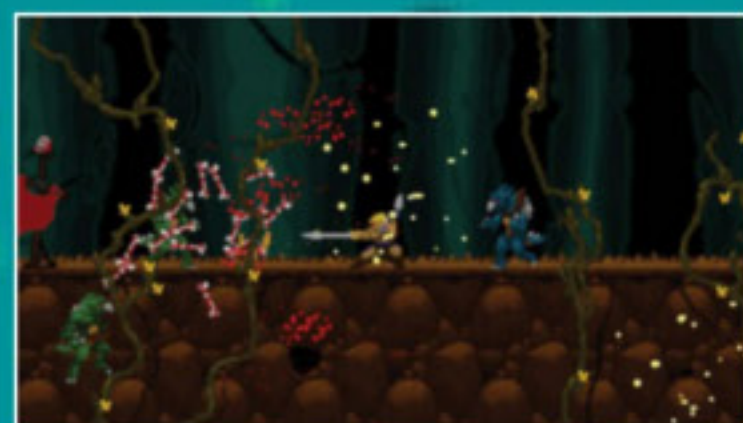

► [PC] *Volgarr The Viking* was backed by fans on Kickstarter, appealing to a particular interest of retro fans.

## INFLUENCES

The games that inspired *Volgarr The Viking*

SUPER GHOULS N' GHOSTS  
ZELDA II: THE ADVENTURE OF LINK  
MAGIC SWORD  
ALTERED BEAST  
CASTLEVANIA  
STAR FOX 64

day just watching the ghosts in the second level of *Super Ghouls N' Ghosts*, trying to figure out exactly how their movement pattern worked. He even reprogrammed how characters stand on the edge of ledges multiple times."

Retro side-scrolling beat-'em-ups have had something of a resurgence thanks to PC digital distribution, but it's this kind of dedication that makes *Volgarr The Viking* truly stand out from its peers. The perfection of the mechanics means that even when everything is being thrown your way, it never quite feels like you're being overwhelmed unfairly. Much like the side-scrolling beat-'em-ups that inspired so many of *Volgarr's* mechanics, the reliance on player skill is always at the forefront – a factor that has led to many gamers aiming for that perfect 100 run. ★



► [PC] The enemy attack patterns are intentionally simple and easy to learn, the challenge coming from unique terrain.

“We spent a whole day just watching the ghosts in the second level of *Super Ghouls N' Ghosts* trying to figure out exactly how their movement pattern worked”

Co-developer Kristofer Durrschmidt reveals the team's attention to detail

► [PC] Hidden paths often lead to reward, either more gold (for points) or armour for Volgarr.



► [PC] The strict arcs of the leaps recall the classic retro feel of having to line up your jumps perfectly.

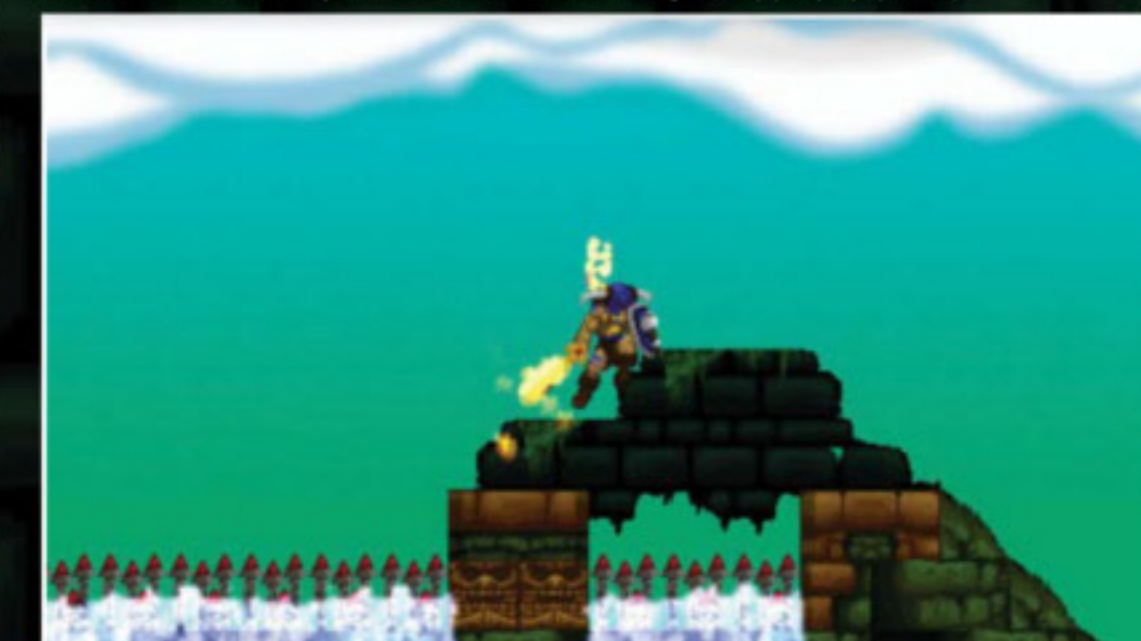

THE TEAM  
The people that made *Volgarr The Viking* happen

KRISTOFOR DURRSCHMIDT  
EVERYTHING

TARON MILLET  
EVERYTHING

## THE TEAM ON VOLGARR THE VIKING



**DARRAN JONES**

Like an idiot I forgot to back *Volgarr The Viking* on Kickstarter. It wasn't that I didn't like the idea of it, I just forgot. Don't make the same mistake as me and download this classy brawler immediately.



**NICK THORPE**

Don't be fooled by the cute sprite design, as *Volgarr* is a brutally tough game. It's certainly challenging but never unfair, allowing you to really appreciate the clever stage design.



**JONATHAN WELLS**

I've only just recently experienced *Volgarr* due to it arriving on Xbox One's Gold Service. It's a little too difficult for me, but there's no denying that it's a very slick-looking game.



**DAVID CROOKES**

I've not actually had a chance to experience *Volgarr The Viking* yet, but its neat sprite design and clever clothing system has certainly caught my eye. Here's hoping it hits PS Vita.

INSTRUCTION MANUAL  
FOR  
NUTTING INDUSTRIES

# NUTTING INDUSTRIES

When you think of the pioneers of the modern coin-op industry or the game console business, names like Bushnell and Baer come to mind along with companies like Atari or Magnavox. As Marty Goldberg shows, the last name Nutting deserves a similar level of reverence

**W**hile most talk of the early video arcade industry usually centres around Nolan Bushnell and Atari, there's another individual whose firms and their contributions to both video arcade games and the coin-operated amusements industry overall are arguably equally as important. Nutting Industries (NI), Milwaukee Coin Industries (MCI) and Dave Nutting Associates (DNA) were a succession of companies spanning a 17-year period of innovation, resulting in products that either redefined the way things were or led the way in showing how things were moving to become. All three were also created by the venerable David Nutting.

The story begins in 1966 when David was working at Brooks Stevens Design Associates, a product design firm with experience in every industry. Seriously, every industry. By this time Brooks Stevens had designed everything from the original Oscar Meyer Wienermobile to logos and packaging for Miller Brewing to the very first SUV, the Jeep Wagoneer, which David had assisted on as well. It was around this time in 1966 that David got a call from his brother, Bill Nutting. "Bill gave me a call and told me about his idea and asked me if I would be interested in repackaging

his teaching machine into a coin-operated game," says David. That idea was a plan to get both brothers into the coin-op industry, an industry they knew nothing about, with a new 'game' based on a product Bill had been an investor in. That product, a teaching machine for the US Navy, was designed to test students by using a filmstrip projected onto a screen to ask multiple-choice questions. Students would then answer by pushing A, B, C, D or E buttons. During one of their meetings, one of the other investors jokingly suggested, "Why not put a coin slot on the quiz machine and make it an entertainment device?" So now here was Bill asking if he could leverage David's design and engineering background to do that very thing. "I want you to help repackaging my group's multiple-choice teaching machine into a coin-operated quiz game," came the call to his brother David in Milwaukee, Wisconsin, setting up the same successful start-up formula mirrored later by Bushnell/Dabney and Jobs/Wozniak; the visionary and the doer.

As David recalls, "Bill was learning that coin-operated equipment was sold through distributors located in the major cities. Bill flew out to Milwaukee where we spent several days putting together a plan. At the same time, Bill visited distributors in Chicago, Detroit and New York, learning more about the

FIG.1

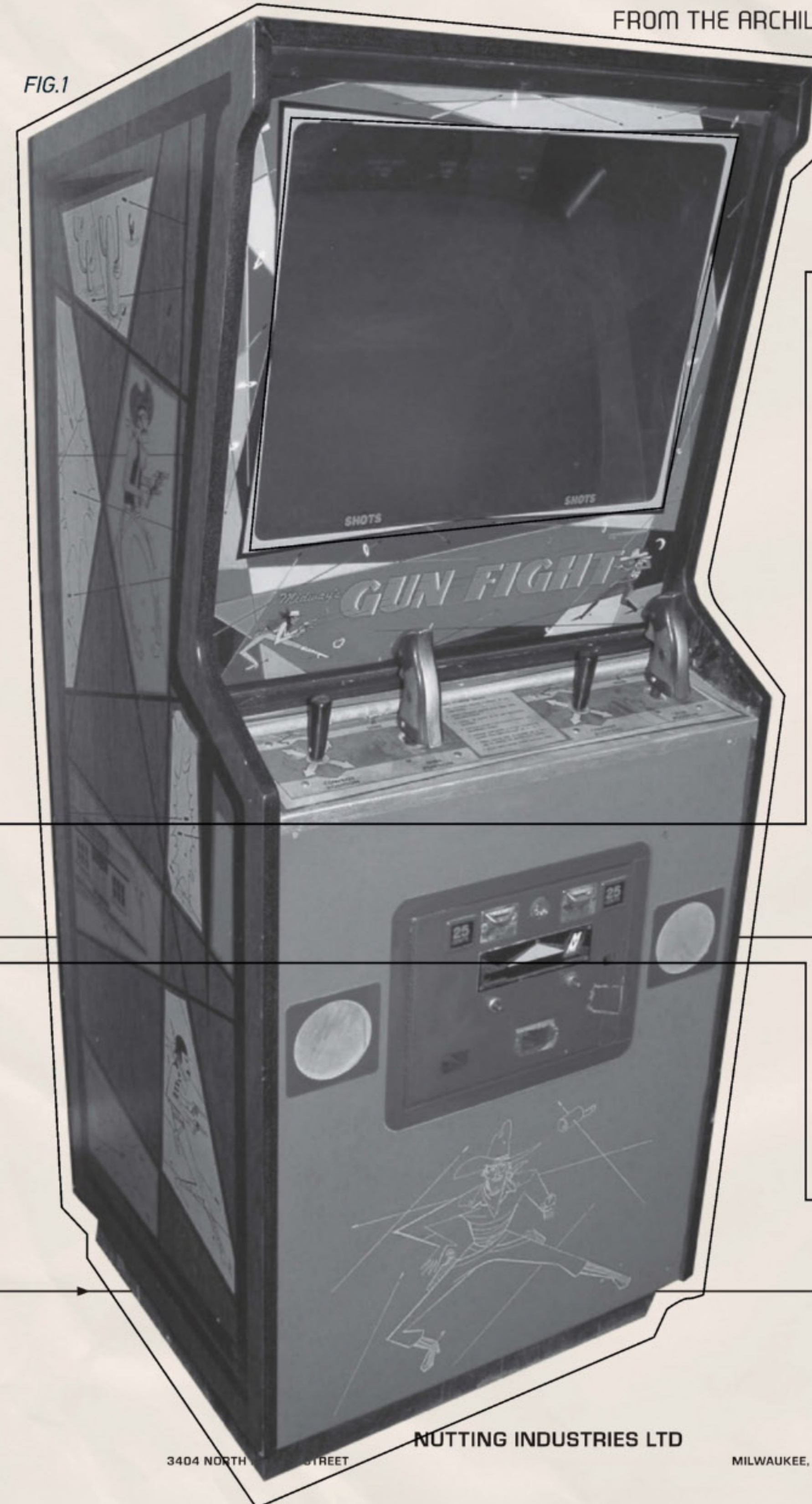

FROM THE ARCHIVES: NUTTING INDUSTRIES

## IN THE KNOW

- All three companies were started by the same person, David Nutting.
- They also all shared the same location, though Dave Nutting Associates eventually moved to Chicago.
- Dave Nutting Associates pioneered the use of microprocessors in pinball and videogames.
- *Gun Fight* was the first videogame with bitmapped graphics.
- Dave Nutting Associates also did the even more popular follow-up to *Gun Fight*, entitled *Boot Hill*.
- Programmer Jamie Fenton (*GORF*) started as a research assistant in a Robotics and AI Lab at UW-Milwaukee.
- *GORF* came from Jamie's college nickname, Froggy. "I had frog stuff all over my office. David wanted to do a shooting game (with the rifle on the trackball). He created a *GORF* character from that."
- Managers at MCI's Red Baron Amusement Centers weren't your typical arcade managers of the time. They were given training in working with people and the supervision of children.
- *Sea Wolf* was almost named 'Charlie the Tuna' thanks to executive Richard Welu during a period when Bally was licensing big names. It was pointed out that Charlie was a loser ('Sorry Charlie') and instead it was named *Sea Wolf*... by a night maintenance man who was a fan of the Jack London novel of the same name.

» [Fig. 1] Midway's *Gunfight* (1975). The first videogame with a microprocessor, thanks to Dave Nutting Associates.

## TIMELINE

- 1962** IQ COMPUTER DEVELOPED. LAUNCHES NUTTING INDUSTRIES AND, TOGETHER WITH BROTHER BILL'S NUTTING ASSOCIATES AND THEIR COMPUTER QUIZ TWIN, OPENS UP THE COIN-OP INDUSTRY TO THE NON-TRADITIONAL LOCATIONS OF ARCADES, BARS AND BOWLING ALLEYS.
- 1967** RED BARON IS RELEASED. A HIGH-TECH ELECTROMECHANICAL GAME THAT USES FILMSTRIPS TO PROVIDE PRE-RENDERED FLIGHT SCENES, EXPLOSIONS AND EFFECTS FOR GAMEPLAY. PREDATES LASERDISC GAMES LIKE DRAGON'S LAIR, WHICH USED THE SAME CONCEPT.
- 1970** MCI IS FORMED FROM THE ASHES OF NUTTING INDUSTRIES. RED BARON AMUSEMENT CENTER DEBUTS LATER IN THE YEAR. THE FIRST ARCADE CHAIN CREATED AND OPERATED BY A COIN-OP MANUFACTURER (MCI). BALLY RESPONDS IN KIND TWO YEARS LATER WITH THE ALADDIN'S CASTLE CHAIN OF ARCADES.
- 1972** DAVID NUTTING AND JEFF FREDERIKSEN FOUND DAVE NUTTING ASSOCIATES AND CREATE THE FIRST MICROPROCESSOR-DRIVEN PINBALL MACHINE. THEY ALSO DEVELOP THE FIRST MICROPROCESSOR-DRIVEN VIDEO COIN-OP HARDWARE.
- 1974** BALLY SUBSIDIARY MIDWAY MFG RELEASES GUN FIGHT, THE FIRST MICROPROCESSOR-BASED VIDEO ARCADE GAME. DEVELOPED BY TOM MCHUGH FROM THE DISCRETE ELECTRONIC-DRIVEN GUN FIGHT BY TAITO, HE DOES SEA WOLF THE FOLLOWING YEAR BEFORE LEAVING FOR RURAL WISCONSIN AND RELATIVE OBSCURITY.
- 1975** BALLY RELEASES THE DAVE NUTTING ASSOCIATES-DEVELOPED HOME LIBRARY COMPUTER. LATER KNOWN AS THE PROFESSIONAL ARCADE AND ASTROCADE. DESIGNED TO BE A HYBRID GAME CONSOLE AND PERSONAL COMPUTER. IT'S THE FIRST WITH FULL-COLOUR HI-RES BITMAPPED GRAPHICS.
- 1977** MIDWAY MFG RELEASES JAMIE FENTON'S GOLF. FEATURING SEVERAL GAMES IN ONE, INCLUDING VERSIONS OF GALAXIANS AND SPACE INVADERS. IT ALSO FEATURES SPEECH SYNTHESIS AND BECOMES AN INSTANT CLASSIC.
- 1985** MIDWAY MFG RELEASES DAVE NUTTING AND ALAN MCNEIL'S WIZARD OF WOD. WITH ITS CREEPY ORGAN MUSIC AND TAUNTING SPEECH-SYNTHESIS-DRIVEN LINES, IT ALSO BECOMES AN INSTANT CLASSIC AND ALONG WITH GOLF IS IN GREAT DEMAND BY COIN-OP COLLECTORS TO THIS DAY.
- 1990** DAVE NUTTING ASSOCIATES IS SHUT DOWN BY BALLY. THE SURVIVING MEMBERS GO ON TO FIELDS SUCH AS QUANTUM PHYSICS AND SOFTWARE DEVELOPMENT.

FIG.2



» [Fig. 3] David Nutting working at the drawing board in 1972 at MCI. FIG.3

» [Fig. 2] The original headquarters for all three companies at 3404 N Holton Street in Milwaukee, WI as it appeared in 1972 when it was known as MCI.

business. My expertise was design and engineering and Bill's was in marketing. So our verbal arrangement at that time was that I would design and engineer the final product and Bill would be the marketing and sales. I had a good friend who was an electronic engineer with Cutler Hammer. Harold (Montgomery) designed all the circuitry and I designed the cabinetry and electromechanical devices like the projector."

The arrangement worked fine as the prototype was developed and tested successfully; that is until another relationship – one that usually takes a toll in any start-up – took precedence. Bill's wife Claire decided she didn't like the arrangement and played the divorce card, threatening to become another notch in a staggering statistic. Silicon Valley has the highest divorce rate in California, and California itself is 20% above the rest of the nation. Bill didn't want to become part of the statistic, so he called David and said he was going to manufacture the game in California and that David should shut down his operation. The news wasn't what David wanted to hear, but it was also obvious to David that the current working relationship he had with his brother wasn't going to work. He had already sunk way too much money into the operation to stop. So the brothers went their own ways and started their own companies to market the same game. Bill, under Nutting Associates, would be marketing it as *Computer Quiz* and Dave, under Nutting Industries, would be marketing it as *IQ Computer*. Setting up a manufacturing location at 3404 N Holton St in Milwaukee and hiring Eugene Wagner for marketing, David's game became an instant success (as did brother Bill's), though for a reason neither of them initially knew about.

The US coin-operated industry was in the midst of a long battle against the stigma of gambling and organised crime; something it would not shed until the 1970s when videogames took over the industry. New York State even had a ban on pinball games that lasted for over 30 years, treating them no differently than slot machines or other gambling devices. By the late 1960s, the industry had organised under the Music Operators of America (MOA). The MOA's existence owes itself to the age-old battle against the US music industry that Steve Jobs more recently fought in the format of digital rights management (DRM) and 'renting' of digital music. That being the music industry has consistently tried to squeeze every nickel and dime out of people's enjoyment of music that they could. The MOA was started in 1948 by a group of influential jukebox distributors and operators to fight against the repeal of the jukebox royalty exemption. It eventually grew to become a powerful organisation representing the entire spectrum of coin-operated devices, including electromechanical, pinball, pool tables, jukeboxes and vending machines.

At the time of the release of *Computer Quiz* and *IQ Computer*, the MOA had been working hard to fight the typecasting of coin-operated machines, specifically pinball – a stigma that had severely limited the number of locations operators could place machines. For instance in Los Angeles, California, about six hours south of where Bill was living, pinball machines were banned until the mid 1970s. The Nutting brothers' games proved to be the right tool at the right time as operators used the machines to work their way into new locations. Both games could go

FIG.4

NO.	DESCRIPTION	DATE	STATUS
653	18 WHEELER	280 Compact System	3/23/78
654	EDC		
655	BALLY BLACKJACK (PIN BALL U.S.)		4/10/78
656	BALLY STRIKES & SPARES		4/12/78
657	Video Pinball	VOID	4/24/78
658	Home Computer add. on		DNA 5/5/78
659	CRT Memory		
660	Dual-Digital Tape add. on		
661	Print		

» [Fig. 4] A page from Bally's own project logbook showing some of the projects being pursued in 1978. A fair portion were by Dave Nutting Associates (listed as DNA).

everywhere because of their perceived edutainment value. Operators would get into a location with the game, establish a relationship and then slowly bring in pinballs, pool tables and vending. In a lesson learned by both Nuttings and later leveraged by Nolan Bushnell with his creation of the fake competitor Kee Games, the fact that there were two manufacturers of 'Quiz' games also awoke the marketplace and opened up more operators and locations. In the amusement industry at that time, a great manufacturing run for a machine like a pinball was somewhere around 1,000 to 1,500. *Computer Quiz* had a run of 4,200 units and *IQ Computer* had a run of 3,600.

Over the next several years, David and Nutting Industries continued on the edutainment arcade game path using the same filmstrip technology, starting with a two-player version of *IQ Computer* called *Dual IQ Computer* and then various quiz replacement packs as well as another version of the unit, called *Golf IQ*. David also looked to diversify by hooking up with a manufacturer and distributor in London, England, creating a subsidiary to market non-coin-operated versions to educational institutions as Modex Inc, and by expanding into food service vending machines via some patents that Harold's father owned. It was the game offerings that needed to grow, however,

## "I wanted to be the industry leader and develop the first microprocessor pinball"

DAVID NUTTING ON OBTAINING INTEL'S FIRST MICROPROCESSOR DEVELOPMENT SYSTEM

and in 1969 they introduced *The Puzzler* designed by that same London firm. Ward Marty Johnson would replace Eugene as marketing head by the end of 1969, just as they were working on their most ambitious project. Initially titled 'Leisure Time Coin Game', by the time of its unveiling in October 1970 it was renamed *Sensorama*. The first arcade game to feature a professional sports tie-in, it was designed for placement at bowling alleys and featured 13 audiovisual bowling lessons given by pro bowler Dick Ritger.

By 1970, though, it was clear that these educational arcade games were running their course, and with electromechanical (EM) arcade games already being dominated by the likes of Bally, Midway, Chicago Coin, Williams and Sega, a new format was needed. Brother Bill Nutting and his Nutting Associates got their new format in the form of video-display-driven arcade games when Nolan Bushnell had called up Bill's sales manager David Ralstin out of the blue. David was certainly open to the same synergy between new technology and games happening, and went so far as to place ads in local newspapers looking for people to submit ideas. However, overall he wanted to expand the projection technology into fully projected games based far away from the realm of quizzes. Looking to create a unique first-person experience with WWI airplane dogfights, in 1970 he began work on what would be the last game released under Nutting Industries, *Red Baron*. Using a pre-rendered animated

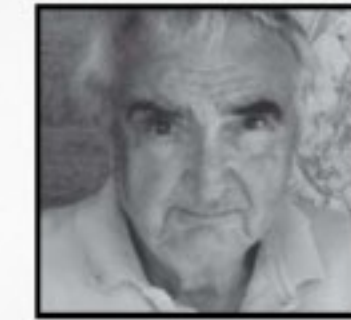

FIG.5



» [Fig. 5] The manual for Nutting Industries' IQ Computer. Together with its twin Computer Quiz by Nutting Associates, it opened up locations formerly closed to arcade games thanks to their steady reputation over the preceding decades.

## WHERE ARE THEY NOW?



### David Nutting

Retired and living in Arizona, in 1984 David had moved to Colorado to study quantum physics. He's now the author of two books, the 2005 released *Language of Nature - Quantum World Revealed* and the 2012 *Secrets to a Creative Mind: Become the Master of Your Mind*.



### Jamie Fenton

Jamie now lives in Sunnyvale, California. Spending the last 30 years working for a long line of game, graphic and software company start-ups, she currently works for Amazon's Lab 126 on the multimedia and performance teams for the Amazon Kindle and Kindle Fire tablets.

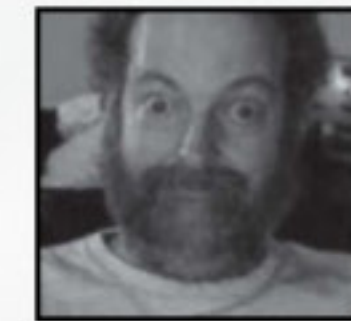

### Alan McNeil

After creating the follow-up to *Berzerk*, called *Frenzy* for Stern Electronics, Alan also went on to do *Winter Games* and *Sub Battle* for Epyx, but has chiefly spent the last 30 years as a software developer writing apps across a plethora of platforms as a consultant.



FIG.6

» [Fig. 6] A special coin David Nutting had minted to give out at the Music Operators of America (MOA) show in 1968 – the main coin-op show in America.

film that functioned by jumping to different animations, much in the same way LaserDisc games like *Dragon's Lair* would some 12 years later, the player was given the sense of flying a WWI biplane into aerial combat. It was accompanied by recordings of actual machine-gun fire and plane engines along with haptic feedback in the form of the controls vibrating every time the plane's gun was fired. Unfortunately, Nutting Industries ran into bad financial problems afterwards, forcing David shut it down and start over...

It was in the exact same location, and with some of the same people, but on paper Milwaukee Coin

FIG.7

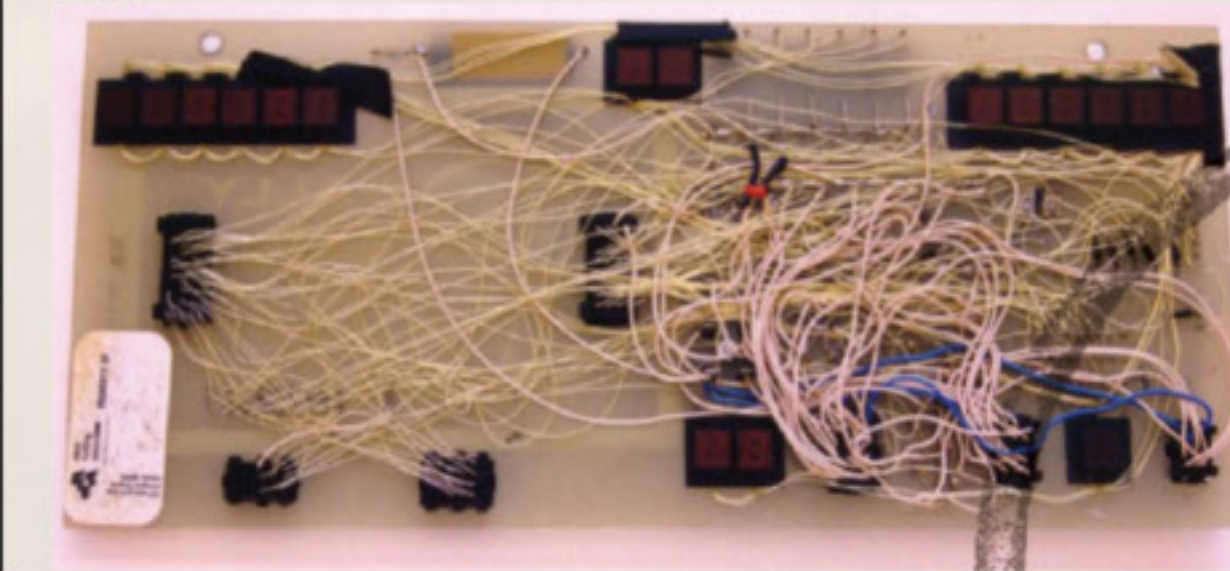

» [Fig. 7] The processor card for the Flicker pinball machine that David and Jeff retrofitted to use a microprocessor.



FIG.8



» [Fig. 8] David Nutting's brother Bill with his most famous product, *Computer Space*.

FIG.9



» [Fig. 9] Jamie Fenton's video coin-op development station around the time of her games *GORF* and *Robby Roto*.

Industries (MCI) was a brand new company. MCI was carrying on where NI had left off and producing film-driven war-themed arcade games like *Blue Max*, *Desert Fox*, *U-Boat* and *Flying Ace*. However, it was the direction that David and the MCI board wanted to take in 1972 that really set MCI apart from other coin-op companies. Firms at the time sold to distributors and what are called operators, the people who actually run the machine on location. At the time, most locations were usually arcades, bars and bowling alleys. Coin-op companies might put their own machines out at these locations for testing during development, but they never actually owned the locations.

One of MCI's customers gave it the idea to change all that. During the 1960s, Jules Milman and his company American Amusements Inc had sought to wipe out the negative image of arcades by designing a new breed that were to be placed at the then new concept of mega shopping centres in the Chicago area, more commonly known as shopping malls. Called Carousel Time, these family-friendly locations with carpeting and a ban on smoking and eating on the premises were far different than their seedy penny arcade counterparts. The success of Carousel Time led the MCI board to decide it should look into running its own mall-based locations featuring MCI games. Based on the successful *Red Baron* game (which had spawned the recent *Super Red Baron* follow-up by MCI), the first Red Baron Amusement Center debuted in the Milwaukee area Mayfair mall in 1972. Within the year they had grown to about seven locations in the Midwest. Nolan Bushnell also tried to duplicate the idea in 1973 with Atari's own mall-based arcades in the San Francisco Bay Area, such as at Bay Fair Mall, but it never quite caught on (at least not until he combined it with pizza to create Chuck E Cheese). However, future

David Nutting partner Bally did manage to succeed with its own in 1974... by purchasing American Amusements and rebranding it as the (more recently) well-known Aladdin's Castle.

**W**ith the success of the locations and the EM arcade game market starting to shrink during 1974, the MCI board wanted to concentrate its resources on the *Red Baron* locations. David, meanwhile, wanted to investigate the new form of electronics called microprocessors. The gateway into this futuristic world arrived via an Intel rep who had stopped by MCI to extol the virtues of the firm's soon-to-be-released 4040 4-bit microprocessor. He took new hire Jeff Frederiksen, who had experience programming a Burroughs mainframe computer, down to an Intel seminar in Chicago. "I wanted to be the industry leader and develop the first microprocessor pinball. I convinced them to sell us one of the first microprocessor development systems," says David.

Developed under a consulting contract with Bally, the pinball project also led to the creation of the final Nutting company in this article, Dave Nutting Associates. David formed DNA, a game engineering firm, as a partnership between him and Jeff Frederiksen in the early summer of 1974. On 20 August, Bally in turn sent them two Flicker pinball machines (a game yet to be released) to retrofit into solid-state microprocessor-based prototypes as proofs-of-concept. Completed by September, the new system was demoed to Bally management at the end of the month and over the next several years became the blueprint for the burgeoning microprocessor-based pinball industry, whose machines were distinguished by their glowing LED score displays.

It was right around this time that the duo pursued their greatest accomplishment, however. The Intel 8080 had been released that past April, and according to David, "As soon as we were able to acquire the 8080 processor we developed our videogame hardware based on a mass RAM system. For every pixel on the screen we had a dot in memory, giving us full control of the entire screen." What David is describing is the frame-buffer-based process now used by every videogame coin-op and console known to man: bitmapped graphics. Already in use in high-end graphics research computers at the time, David and Jeff were the first to see its potential in videogames. Video arcade games and home consoles in that period were manually generating hardware-based sprites (called 'stamps' in coin-op industry speak), even once microprocessor-based games became more common. So the process they introduced was truly far ahead of its time, enough so they knew they'd need to look for some programmers to hire for future projects.

Jeff had been attending UW-Milwaukee at the time he joined MCI and studying under Richard Northouse, a professor in the School of Engineering and Computing. Approached for some students skilled in programming, Richard contracted out two: Tom McHugh and Jamie Fenton. Recalls Jamie, "I entered the game business a little reluctantly. All the tales about Bally being part of the Mafia etc. Since I was in Milwaukee, I did not know about the Chicago scene. For a few weeks we worked for Richard and were later hired on directly to DNA. My first assignment was 'Mirco Pin'. Mirco was a pinball company that Jeff and David pursued a relationship with independently of Bally. It was like the Bally Fireball but had more going on. After that I got to work on a blackjack game on the videogame hardware and

that really impressed David. I remember the place [where DNA was located] vividly. It was a commercial space shared with the Red Baron arcade game chain, and there were a lot of games to play with. You just wandered around with an extension cord."

According to David, the first game they started for Bally subsidiary Midway on their new hardware was a baseball game (eventually released as *Tornado Baseball*), but it would be Tom McHugh's project that would hit the market first for Bally in November 1975: *Gun Fight*, Midway's licensed version of Taito's *Western Gun*. In a process similar to what they had done for the Flicker pinball machine, the game was gutted and retrofitted with the bitmapped microprocessor-based system they had designed. With *Gun Fight*, the video coin-op industry had just met its future. And as Dave further notes, it wasn't the only industry to be affected. "Our system used a frame buffer of RAM that would write to the CRT. RAM in 1975/76 was in short supply. In order to get a good price on RAM, Midway had to commit over three million dollars on their first release. This order consumed over half of all RAM in production in the world at that time, causing great shortages to other industries." Also according to David, Taito turned around and copied their 8080-based hardware for its game *Space Invaders*.

From there, the now classic *Sea Wolf* (by Tom) and the racing *280-Zzzap* (by Jamie) games followed, along with the previously mentioned *Tornado Baseball*. The string of hits led Bally to buy out DNA outright, and the group moved down to Chicago to essentially become Bally/Midway's research and design wing in the same way that Cyan was for Atari. It was followed later in the year by the start of the design of Bally's simultaneous entry in to the new home computer and programmable



## Action Graphics

In 1981, David Nutting and Bob Ogdon created a spin-off from DNA called Action Graphics to develop games for the Bally videogame system (at that time owned by Astrovision and renamed the Bally Astrocade). The firm was staffed by many of the same people under DNA who had originally been programming for the system when it was directly under Bally. Many of these games were direct ports of Bally/Midway coin-ops but under different titles, such as *Muncher* (Pac-Man), *Incredible Wizard* (Wizard Of Wor), and *Space Fortress* (Space Zap). Action Graphics also did original games like *Solar Conqueror*. As the third-party demand for other consoles like the 2600, 5200 and Colecovision started to explode in 1982 and 1983, Action Graphics started doing contract work creating games for many of these third-party companies, or in some cases porting games they had done on another platform. In an example of the latter, they did Activision's ports of *Beamrider* for the Atari 5200, Atari 8-bit computers, Colecovision and Commodore 64. Action Graphics lasted a year after even DNA had been shut down, though by that time (considering the collapse of the US console industry) it was doing mostly computer games.

## DEFINING GAMES



### Gun Fight 1975

Released by Bally subsidiary Midway Mfg, it was originally titled *Western Gun* and released by Taito in Japan. DNA turned it into a microprocessor-controlled arcade videogame, introducing software coding to the industry. According to David Nutting, its release caused a RAM shortage in other industries. It's also the first game to feature bitmap graphics, a concept only previously available in high-end graphics research systems at universities and corporations.



### Sea Wolf 1976

Featuring a life-size periscope, it's essentially a videogame version of Midway's earlier electromechanical games *Sea Raider* and *Sea Devil*. Its advanced sound effects and first-person environment proved a big hit in the mid-1970s and it remained one of the most popular games of the period until Midway released Taito's *Space Invaders* in 1978. That same year, the sequel *Sea Wolf II* was also released, allowing two-player action with side-by-side periscopes.



### Boot Hill 1977

The 1977 follow-up to *Gun Fight*, *Boot Hill* was programmed by Alan McNeil who later did the arcade classic *Berzerk* for Stern. Using dual joysticks to control the positions of the cowboy and his gun, it also features a colourful western backdrop that the game is projected onto via a reflective glass technique common in games of the period. Besides expanded gameplay, it also added a death song and burial of the player on the infamous *Boot Hill*.



### GORF 1981

Jamie Fenton's classic shoot-'em-up features several games in one, along with speech synthesis. "We used the TI speech chip -- sometimes [it] would vocalise using garbage memory and it sounded like people speaking in tongues." With levels that included licensed versions of Namco's *Galaxians* and Taito's *Space Invaders*, that reason alone is why there are not many *GORF* ports out there, according to Jamie.

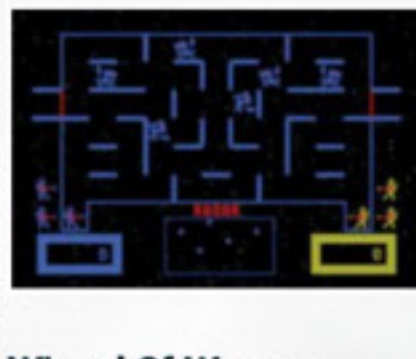

### Wizard Of Wor 1981

David Nutting and Bob Ogdon's game was inspired by the scene in *Alien*, where Sigourney Weaver is tracking the escaped alien via a small monitor. Using the same speech system and style of taunting as *GORF*, the standout feature is its very theme: the wizard. "When we put a voice into the machine, that got us into the mythology of who, exactly, was doing the talking. So we invented the Wizard. We used the Wizard to disrupt the flow of the game," explained co-designer Bob Ogdon to Arnie Katz in 1982.

"This order consumed over half of all RAM in production in the world at that time"

FIG.10 DAVID NUTTING REVEALS HOW GUN FIGHT'S PRODUCTION CAUSED A GLOBAL RAM SHORTAGE



» [Fig. 10] DNA developed this hybrid game console and computer system in 1976, released in 1977. It was later renamed the Bally Professional Arcade and then Astrocade.

FIG.11



» [Fig. 11] The back of the microprocessor-driven Flicker pinball machine's backglass showing the modifications Jeff and David made to support LED-based scoring (the first of its kind).

console markets: The Bally Home Library Computer. Created as a full-colour bitmapped personal computer and gaming console (the first bitmapped frame-buffered console, in fact) that could also be leveraged in new coin-op designs, it saw a mail-order-only release in September 1977, with wide release in 1978 as the Bally Professional Arcade. More hits followed for DNA, most notably *Wizard Of Wor* and Jamie's smash game *GORF*. However, the video coin-op industry went through a crash starting in '82, causing many firms to either downsize or leave all together. Sadly, DNA didn't survive and was shut down by Bally in early 1984. Interestingly though, this was just as Bally was acquiring the game firm Sente (founded by several ex-Atari coin-op engineers and helmed by none other than Nolan Bushnell), which would serve the very same purpose as DNA over the next four years. ★

Special thanks to Keith Smith.

# Ape Escape

THIS IS NO TIME FOR MONKEY BUSINESS!

RETROREVIEWAL



NT

» PLAYSTATION

» SONY COMPUTER ENTERTAINMENT » 1999

**As a PlayStation-owning teenager, I resented *Ape Escape* a little bit.** Not

because it was a bad game, mind you – it was a good game I just couldn't play, because unlike the vast majority of PlayStation releases it demanded a Dual Shock controller. Never mind the fact that the game and pad were available as a bundle, I already had two standard pads and saw being forced to buy a third as a simple cash grab by Sony. Dear readers, this is merely more evidence that I was not a smart kid, since I later learned that *Ape Escape* is an essential PlayStation game.

*Ape Escape* is the sort of game that, earlier in the Nineties, people had thought to be impossible on the PlayStation. The system had struggled to deliver the sort of open environments seen in N64 platformers, with *Crash Bandicoot* – the PlayStation's most prominent platforming series – limited to very linear pathways. But if you're going to chase monkeys around, they need to have places to run, and *Ape Escape* certainly delivered on that front.

The Dual Shock controller was definitely a necessity, too. Even the L3 and R3 buttons were brought into play in a control scheme that was a more little complex than average, but allowed for greater ease of monkey-bagging, with one analogue stick controlling the player and the other swinging the net. For the sake of not buying a new controller, passing up on *Ape Escape* was a big mistake – but thankfully, one I've now rectified. ★

L2





>> Our latest issue looks at the spiritual successor to *Micro Machines*, takes to the skies with the remastered *Wings* and discovers if *Halo* is still the definitive first-person shooter



## Toybox Turbos CAN CODEMASTERS RECAPTURE THE MAGIC OF MICRO MACHINES?

- INFORMATION**
- » **FEATURED SYSTEM:** PC (STEAM)
  - » **ALSO AVAILABLE ON:** PS3, XBOX 360
  - » **RELEASED:** OUT NOW
  - » **PRICE:** £11.99
  - » **PUBLISHER:** CODEMASTERS
  - » **DEVELOPER:** IN-HOUSE
  - » **PLAYERS:** 1-4

- BRIEF HISTORY**
- » The original *Micro Machines* made its debut on the NES, quickly getting ported to many other home systems. It became a big success for Codemasters and numerous sequels followed, including two spin-offs in the form of *Micro Machines Military* and *Micro Maniacs*. The last game, *Micro Machines V4*, was released in 2006.

» [PC] While the environments do a good job of emulating the original's, they do feel a little subdued.



**Micro Machines remains one of the greatest party games of all time, so it's a brave, or perhaps**

foolhardy, developer that tries to improve on it. Codemasters is obviously feeling brave, as it's decided to reboot *Micro Machines* – only this time without the actual licence.

From the moment *Toybox Turbos* loads up with its very familiar-looking logo, it's obvious that this is a new *Micro Machines* game in all but name. The colourful tracks made from everyday items are present, there's a solid collection of toy vehicles to collect and the amazing multiplayer mode that made the original games so much fun to play is all present and correct. Start playing *Toybox Turbos*, however, and you start to realise that while the game is obviously very enjoyable, it lacks the magic that made the earlier 2D titles such a joy to play.

This is most noticeable when you consider the handling of the many vehicles on offer. There's an impressive range from which to choose, from ice-cream vans to roadsters and bulldozers, but the handling is not as tight as we'd like. The controls often feel a little floaty, meaning you don't always feel that you have full control over your car. Things are noticeably improved when playing with the D-pad, but it still lacks the

precise controls that made the early 2D games so much fun to play, or even the solid handling of *Mashed*.

While the handling isn't as tight as the earlier games, Codemasters has included a variety of game modes to keep the gameplay fresh and exciting. Classic is your bog-standard four-player racer, with weapons thrown in for good measure. Time Trail sees you trying to hit a specific time target in three laps, while Overtake has you trying to pass a set amount of other vehicles, again in three laps. Countdown has you racing against an ever-decreasing clock, requiring you to pick up alarm clocks to extend your timer, while Escape has you trying to outdistance a wave of water for a specific distance. Eliminator is saved for the boss battles, tough encounters that can be more than a little frustrating on the later stages.

» [PC] Coins are used to unlock new vehicles. Don't worry, they're all surprisingly easy to collect.

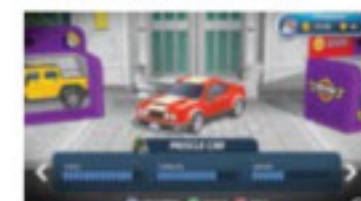

» [PC] Who says overtaking a continuous number of identical vehicles can't be fun?



REVIEWS: TOYBOX TURBOS

### Micro Machines: A selected history



#### Micro Machines

The original NES classic instantly gained attention thanks to its highly addictive gameplay, well-designed courses and miniature theme. Its success led to ports for other consoles and computers.

#### Micro Machines 2: Turbo Tournament

This sequel delivered a host of new vehicle types, each handling differently. It also introduced a league mode while the Mega Drive cartridge had four-player support.

#### Micro Machines Turbo Tournament '96

This Mega Drive exclusive is the best in the series. In addition to new and updated tracks it also features a superb construction kit, meaning lots of lovely longevity.

#### Micro Machines Military

Another Mega Drive exclusive that only appeared in PAL regions. It's notable for including a selection of military vehicles, but suffers from having frustrating time limits and balance issues.

#### Micro Machines V3

This was the very first *Micro Machines* game to be portrayed in 3D and it was huge to boot with 48 courses, 32 vehicles and a selection of different game modes. It catered for up to eight players, too.

#### Micro Machines V4

The last *Micro Machines* game had an emphasis on collecting, with 750 vehicles to find and trade. It also included a silly number of power-ups, from homing missiles to plasma guns.



» [PC] The mashing hammer makes a return, but feels a little too powerful, particularly in Elimination.

#### ★ WHY NOT TRY

##### ▼ SOMETHING OLD SUPER CARS (AMIGA)



##### ▼ SOMETHING NEW TABLE TOP RACING (PS VITA)



opportunity to play online, the local multiplayer does a very good job of emulating the thrills and spills of the original games. There are a number of useful options on offer and the point system used is classic *Micro Machines*, right down to the bouncing the victorious car makes. In fact, the only real downside is the inclusion of the aforementioned mines, which takes a great deal of skill away from an otherwise very balanced mode. Here's hoping a patch comes out to make it an option instead of being compulsory.

Like the multiplayer, the track design is also of a very high standard, with a variety of stages that look as if they've been plucked out of earlier games. Leaping over slices of cakes, racing across ruler-created chasms and skimming across disk-filled sinks will instantly remind you of the franchise's glory days, while a number of interactive hazards – from food mixers to Bunsen burners – ensures that it's not just the other racers you need to worry about. The track design is extremely good, with many of the 18 available tracks

» [PC] Escape mode sees you trying to outrace a never-ending supply of water.

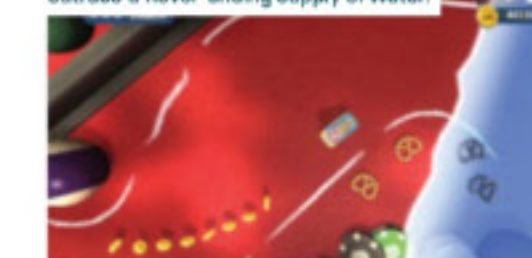

having a variety of shortcuts to exploit. It's something of a pity then that the actual aesthetics of *Toybox Turbos* are surprisingly lacklustre. While it captures the chaotic colours of the earlier games, textures are surprisingly ugly, giving it a somewhat cheap appearance. It's the racing that matters, though, and while it's far from perfect, there's still plenty of goodness here to justify the small asking price. ★

#### In a nutshell

**It lacks the super-tight controls of *Micro Machines*, but the track design and fun multiplayer mode will keep you coming back to it.**

>> **Score 72%**



» [PC] Some will relish the extra challenge that the mines bring, but we found them extremely aggravating.



# Welcome to Homebrew

## NEW GAMES NEEDED

If you have a homebrew project you would like to see featured then please contact us at: [retrogamer@imagine-publishing.co.uk](mailto:retrogamer@imagine-publishing.co.uk)

HOME BREW



>> I've noticed links to Itch.io turning up quite a bit recently; the service is a platform for distributing indie games run by just one person, who is a programmer himself. One to watch for indie gaming fans and it'll be interesting to see if more 8- and 16-bit coders consider it as an option in the future since just about anything can be added.

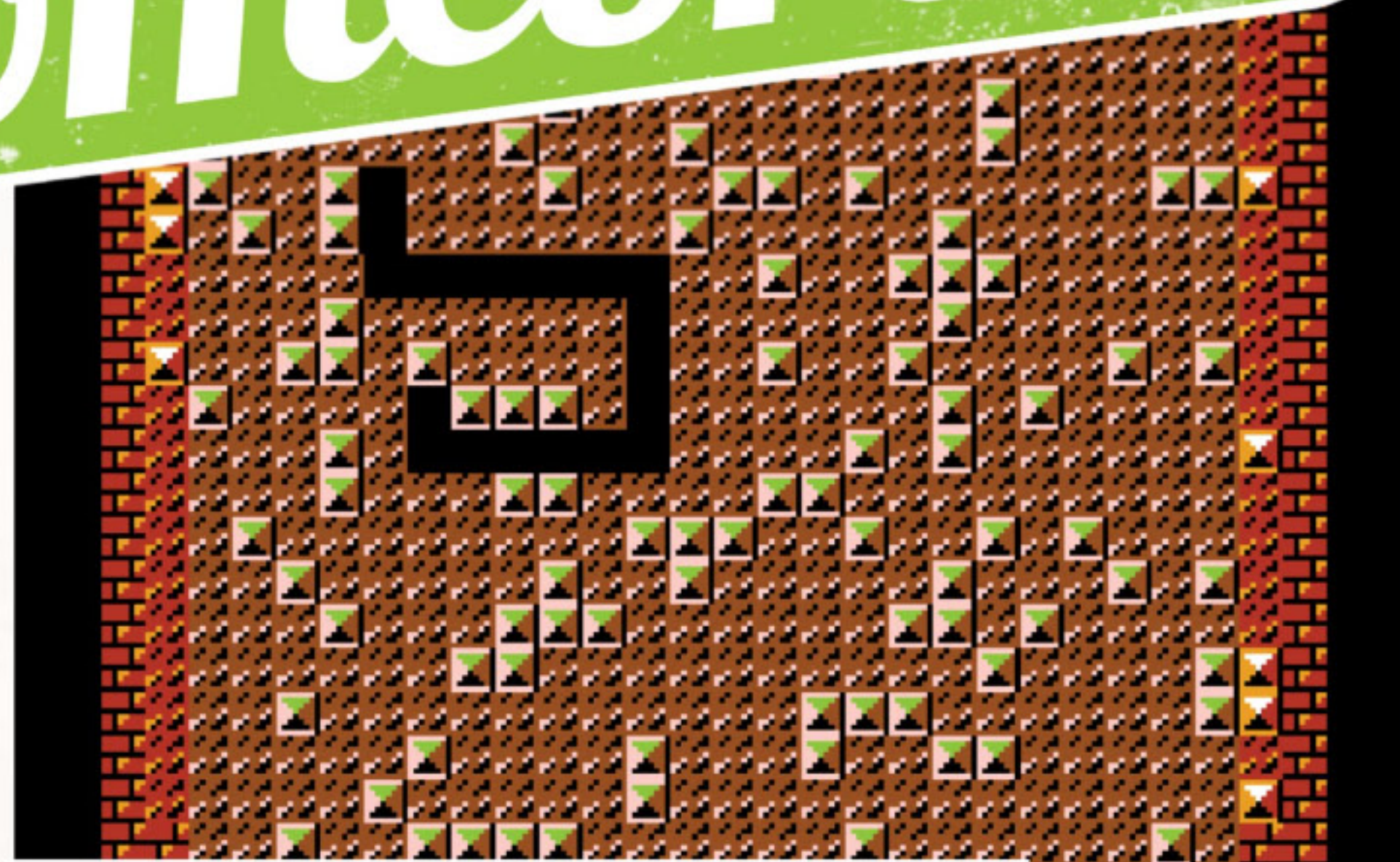

## DO YOU HAVE A FLAG? LEVEL 5

NES homebrew project needs a few dollars more

**B**all 'N' Flag is a simple game for the NES that was developed over a couple of days in BASIC and released in 2013. At the start of each level, the player-controlled ball is dumped into a randomly generated arena and must make its way to the flag before a strict timer expires. Each level increases the number of blocks dumped into the screen and, because they can sometimes be placed in ways that make the objective impossible to reach, the player also has a stock of bombs which can be detonated to blast away the squares directly surrounding their position as needed. An extra bomb is dished out for every level successfully cleared and running out of time will end the game.

So far so simple and many readers who have previously dabbled with BASIC on home computers will possibly have written something similar too, but the game's author, Lionel Barasc, is wanting to take the development of *Ball 'N' Flag* a little further to add things like presentation code and in-game sound. He'd also like to publish the game's source code with documentation – essentially producing a series of tutorials about writing BASIC games on the NES – along with offering the various tools used for download and,

if the funding is there, producing physical cartridges as well. The game can be downloaded in its current form via the page behind [Kikstart.eu/ball-flag-nes](http://Kikstart.eu/ball-flag-nes) for a minimum fee of five dollars and there are links to a couple of places online where there is a free download as well, meaning that it's possible to try before buying. It'll be interesting to see how this game grows if NES owners fund it with those five-dollar purchases; we think it'd benefit from pyrotechnics for the bombs, smoother movement and perhaps enemies.

“It'll be interesting to see how this game grows if NES owners fund it”

## GETTING LOCKED UP

It might already exist as a 'demake', *Super Bread Box* on the C64, but *Super Cell Dungeon* is a reworking of Vlambeer's 2012 indie platformer *Super Crate Box* with a NES-style medieval theme. In other words, it's a platform shooter with lots of enemies to blast! There's still work to do and the website warns that there are likely to be issues and possibly crashes, but the game is operational and supports two simultaneous players as different characters who have unique abilities. Use [Kikstart.eu/super-cell-win](http://Kikstart.eu/super-cell-win) to visit the game's homepage.



[Windows] Busy, busy, busy



[ZX81] The zed-word. Don't say it!

## MORE BRAIINS

We've already looked at the graphical adventure *Zombi Terror* for the Spectrum, but now Kabuto Factory's love letter to zombie survival movies can be played on a 16K expanded ZX81 too; the graphics have been rendered using the machine's text mode rather than relying on an expansion – so they're chunkier than the Spectrum and everything is black and white – but the zombie fighting gameplay remains the same.

Head to [Kikstart.eu/zombi-terror](http://Kikstart.eu/zombi-terror) to find all versions of *Zombi Terror* available for download, along with ordering information for ZX81 cassettes.

## Homebrew heroes



We had a blast playing *Oricum*, so got in touch with José María Enguita for a chat about some of the challenges of making games for the Oric and how to rework *Uridium*

**So to begin with, what led to *Oricum* being developed?**  
It all started as an experiment, really. I wondered if it would be possible to make a fast scrolling game on the Oric including, of course, masked sprites, lots of enemies and elements around, and some kind of parallax effect. The Oric is a bit limited in this area, as there are no hardware sprites, no video chip to help, the screen memory is hardwired – so no hardware double buffer of any kind – and there is certainly not enough CPU power. It seemed difficult, and it was.



[Oric] Not seeing eye to eye.

**There's also a puzzle element to the game. Was that always in your design?**  
Not really. At some point during the development I had most of the elements ready, but I knew I didn't want to make a direct port of *Uridium*. I wanted to mix elements from other classic games and I definitely didn't want to make it just 'kill enemies or targets until the level is done'. Then the idea of the small puzzle came in, but I can't remember if someone else suggested it. The only thing I had somewhat clear from the very early stages in the development is that I wanted to include references to growing up in the 1980s with the music, some enemies, level names etc.

**Were there any particular high or low points during development?**  
There are always low points, I guess. Mostly when you have something nearly working and what is left is to give shape to everything, testing, polishing and cutting out things so you end up with a final product.

**In hindsight, would you have done anything differently?**  
Not sure, I guess that the same system could have been used to make a totally different game, and you are never sure if that would have been a better idea. You always end up regretting not having done this or that bit differently or not being able to include some ideas. I would have loved to be

able to include some original music, but that is simply beyond my abilities.

**What kind of feedback have you received from Oric gamers?**  
Always positive and encouraging. This is an incredible community that gets excited with new developments and always concentrates on the good points. I find myself many times asking for honest criticism, because it's the way to improve. And even criticism is always nice and constructive, so I can only be grateful.

**Finally, do you have any future plans our readers would be interested in?**  
I will rest a bit and will ponder on other projects and challenges that I might get involved in the future. I do these things just to learn and have fun, so I will keep on doing them as long as I am able to. There are many games I love that could be a source for new ideas, and I already have some in mind. I think the next project will be disk-based again – as *Pinforc*, *Space:1999* and *1337* were – to broaden the possibilities.  
Thanks to **Retro Gamer** for the nice interview and keeping the retro gaming culture alive!

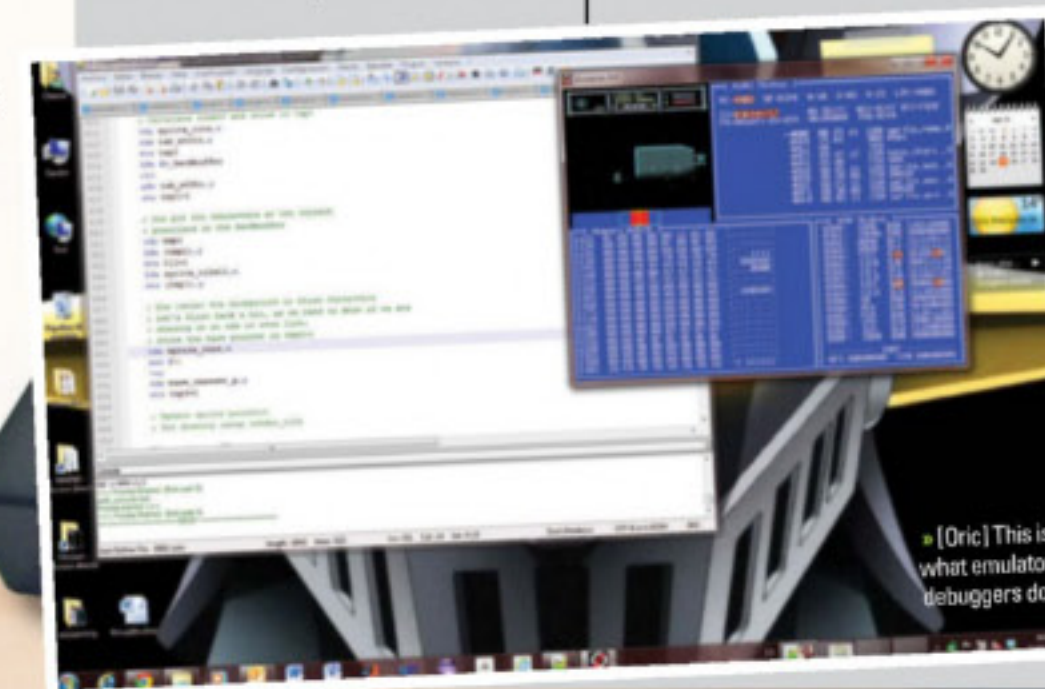

[Oric] This is what emulator debuggers do.

## Incoming

There may be no new Dizzy games, but at least we can always look forward to projects like *Dizzy Day*

[KIKSTART.EU/AIR-SEA-C64](http://KIKSTART.EU/AIR-SEA-C64)



▲ *Air Sea Battle* is a simple C64 shooter written in C – the Melon 64 thread via the URL has more examples.

▼ Ever seen the Atari 2600 pretending to be an LCD game? Well, that's what *Game Panic LCD* does.

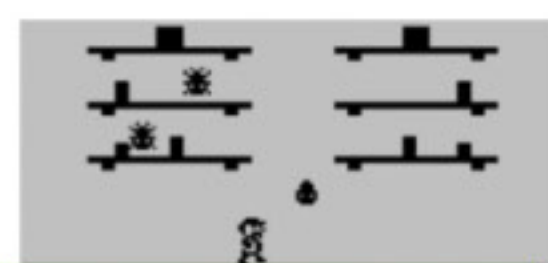

[KIKSTART.EU/GAME-PANIC-2600](http://KIKSTART.EU/GAME-PANIC-2600)

[KIKSTART.EU/DIZZY-DAY-WIN](http://KIKSTART.EU/DIZZY-DAY-WIN)



▲ *Another Dizzy Day* is a traditionally styled Windows or Mac outing for everybody's favourite ovoid adventurer.

▼ Shaun Bebbington's *Minesweep Mini* for the VIC 20 is out, with an enhanced Cronosoft release coming soon.



[KIKSTART.EU/MINESWEEP-MINI-VIC](http://KIKSTART.EU/MINESWEEP-MINI-VIC)

# COUSIN HORACE

» FORMAT: ZX SPECTRUM » DEVELOPER: ALESSANDRO GRUSSU  
» DOWNLOAD: KIKSTART.EU/COUSIN-HORACE-SPEC » PRICE: FREE

Although he's always been a multi-platform character – having appeared on the Dragon 32, C64 and Psion Series 3 – William Tang's creation Horace has over the years become something of a mascot for the Spectrum with his appearances in the three 1980s games being added to over the years by Bob Smith's conversion of *Horace In The Mystic Woods* and other recent titles like the *Horace Miner* series. But this time we're going to be concentrating on Horace's American cousin, a very different-looking Horace who had some surprisingly similar early adventures on the Timex Sinclair.

And this story starts with Cousin Horace at the airport where his British relation is arriving for a holiday. The Guardians, a secretive group whose underground network the Horaces were helping to close down, have pounced and kidnapped poor UK Horace and the journey to save his cousin will see the American counterpart smashing his way through the Guardians' skyscraper, stealing their helicopter in order to fly to the Wild West-themed town of Sleepyville, then avoiding both the wildlife and a visiting biker gang while interacting with the residents and searching for the secret base. Once inside he'll need to locate five disks which have to be fed to the central computer before he and his relation can confront and then try to escape from their mysterious adversary. Each level is a different style of game, including some platforming, a scrolling shoot-'em-up and even some puzzles.

*Cousin Horace* looks to be a real labour of love for developer Alessandro Grussu and the five sub-games are expansive enough that most of them could have been released as standalone titles. The difficulty levels have all been set fairly high – we felt that the shoot-'em-up stage in particular was tricky with its very resilient enemies – but completing the current load earns the player an access code for the next, which can be also be used to return to that stage at a later date. It might be frustrating for some, but players who like exploration and map making should enjoy this journey Stateside.

90%

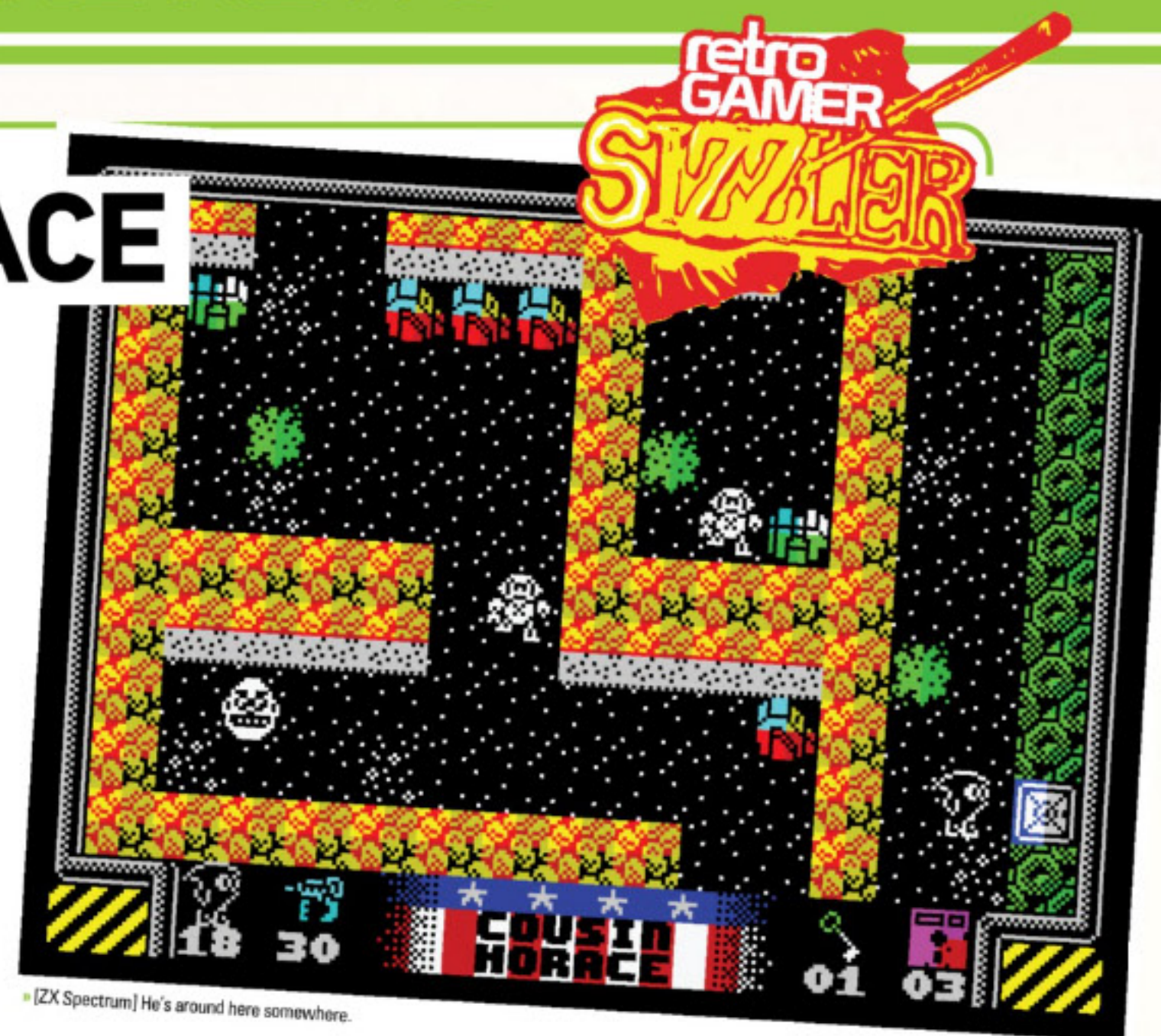

» [ZX Spectrum] He's around here somewhere.

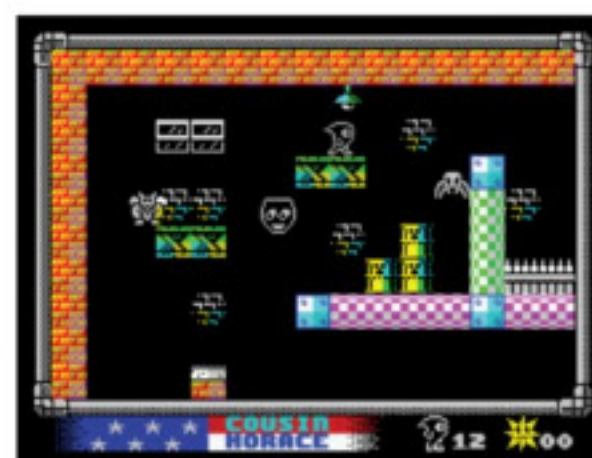

» [ZX Spectrum] Getting a good run-up.



» [ZX Spectrum] Take to the skies with Horace.



# THRO' THE WALL

» FORMAT: SINCLAIR ZX81 » DEVELOPER: UNKNOWN  
» DOWNLOAD: KIKSTART.EU/THRO-WALL-ZX81 » PRICE: FREE

Although its similar name (to *Hole in the Wall*) might set a few readers reminiscing about celebrities in silver Lycra and oddly shaped holes in moving Styrofoam panels, *Thro' The Wall* isn't actually a rip-off from the BBC Saturday night schedules of yesteryear. Instead it was based on the Psion title of the same name, converted from the Spectrum, and shouldn't need any serious explanation since it's a *Breakout* clone relying on the tried and tested bat, ball and wall formula.

We've seen lots of *Breakout* clones over the years on the 8-bit systems, of course, and this one certainly isn't the best since it's somewhat clunky to play and the ball appears to be locked to one of just eight possible directions. However, for ZX81 owners with graphical expansions, this is worth grabbing for a glimpse at what that hardware can do. It's probably best to see this more as a proof of concept, really.

41%

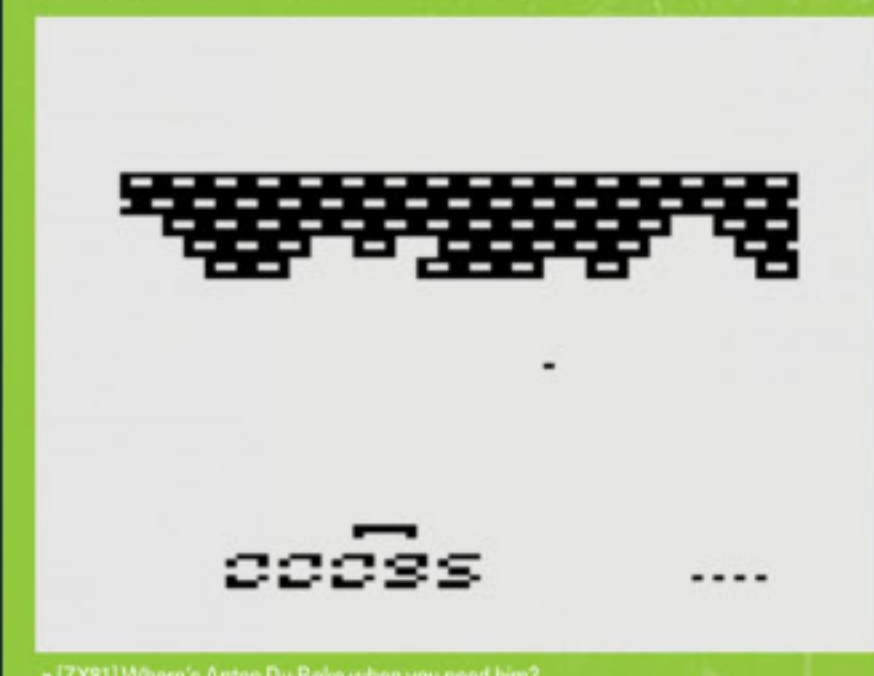

» [ZX81] Where's Anton Du Beke when you need him?

# SECTOR: INVASION

» FORMAT: ZX SPECTRUM » DEVELOPER: DENIS GRACHEV » DOWNLOAD: SECTOR-INVASION-SPEC » PRICE: FREE

*Sector: Invasion* is unashamed single-screen shooting action with a quick pace that feels a little like Jeff Minter's earlier titles such as *Gridrunner* or *Laser Zone* with just a hint of *Hover Bovver*. Each sector is cluttered with alien cells which need clearing with a laser beam, either from the player-controlled craft or the trigger-happy enemies patrolling the screen – in fact, the red cells are immune to attack from your fire so those drones need to be coerced into doing the work.

Letting the nasties clear the rest of the playfield isn't the optimal solution, though, since *Sector: Invasion* is all about getting the highest score and anything they destroy doesn't add to that. Our only complaint was that there aren't

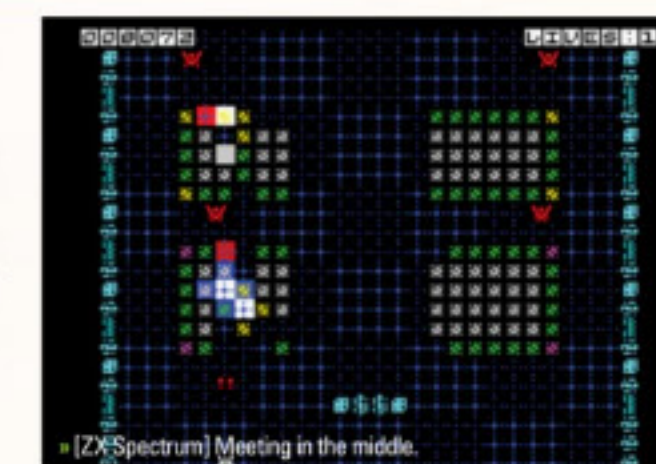

» [ZX Spectrum] Meeting in the middle.

enough levels. Other than this, *Sector: Invasion* is a surprisingly cerebral blaster with good graphics and some excellent music, so it's well worth downloading.

85%

# RED HOT OVERDRIVE

» FORMAT: WINDOWS » DEVELOPER: APRILSKIES AND JIM REED » DOWNLOAD: KIKSTART.EU/RHO-WIN » PRICE: FREE

It's time to take a shiny, high-performance car and hammer down the highway like it was a race track. *Red Hot Overdrive* is a love letter to Amiga driving games from the 1990s, like the *Lotus* series or *Jaguar XJ220*, which was somehow created with the Adventure Game Studio! It isn't just a blast down the road, though: there are other vehicles to avoid, perilous corners and static hazards including the odd cow wandering into the fast lane, all of which will damage the car.

Fortunately, there are petrol stations which can be used to repair damage from impacts and fill the car's tank up. However, the timer doesn't stop while this happens, so there's a balancing act between keeping the car roadworthy and not running out of time between checkpoints. This game is tough as nails and occasionally frustrating, but so were the games to which it pays homage.



82% » [Windows] Where did you get your licence?!

# Make this

Every month our very own Jason Kelk will be teaching you handy new programming techniques. This month: more sprite recycling

NEW

1 We've previously talked about reusing hardware sprites, but in simple ways like *Humanoid* on the Atari 8-bit. This system is workable but means the recycled sprites are 'on rails' and can't move very far vertically, if they even have the option of doing so in the first place.



2 The simple solution is to only recycle some of the hardware sprites so others can move freely, like *Danger Zone* does; this works, but a better option is a sorting multiplexer like the ones in *Crush* or *Commando Arcade* for the C64.

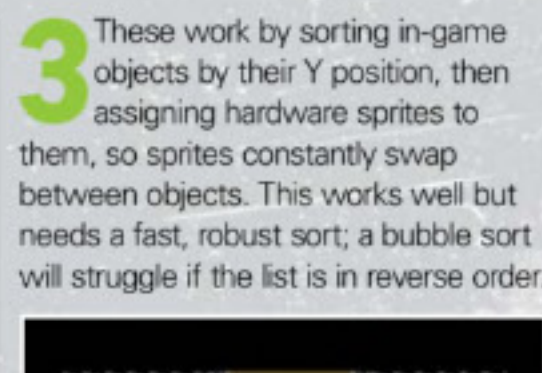

3 These work by sorting in-game objects by their Y position, then assigning hardware sprites to them, so sprites constantly swap between objects. This works well but needs a fast, robust sort; a bubble sort will struggle if the list is in reverse order.



4 Another option is what *Battle Eagle* does: the two hardware sprites used for enemies have their X position split on every scanline from a table, to which objects write. Drawing them in reverse order every second frame helps when they overlap.

# RADIOACTIVE SHIT HAPPENS

» FORMAT: ATARI 8-BIT » DEVELOPER: NOSTY  
» DOWNLOAD: KIKSTART.EU/RADIOACTIVE-A8 » PRICE: FREE

*Radioactive Shit Happens* is a single-screen action game that was written over a two-day period. It sports a tried and tested alien invasion storyline but, while the aliens themselves are harmless and will even run away if touched, the glowing... erm, 'messages' they leave all over the screen are potentially deadly, slowly expanding until they reach a critical mass – at which point they will destroy part of the landscape.

Eventually the area will become uninhabitable, but until then the player has to dash around, scaring off the aliens and collecting as many of their... deposits before detonation as possible. This is a primitive but still entertaining little action game that, apart from the explosive faecal matter, probably wouldn't have been out of place in the Atari 8-bit's catalogue 30 years ago. It's just a pity there isn't on-screen scoring, because that would have increased the longevity a little more.

61%



» [Atari 8-bit] Crept in, crapped and crept out.

# MAILBAG

HAVE YOUR SAY... SEND US A LETTER OR MAKE YOURSELF HEARD ON THE ONLINE FORUM - WWW.RETROGAMER.NET



Don't forget to follow us online for all the latest retro updates

f RetroGamerUK @RetroGamer\_Mag



## CONTACT US

**Snail Mail:** Retro Gamer, Imagine Publishing, Richmond House, 33 Richmond Hill, Bournemouth, Dorset, BH2 6EZ  
**Email:** retrogamer@imagine-publishing.co.uk

# retro GAMER

Imagine Publishing Ltd  
Richmond House, 33 Richmond Hill, Bournemouth, Dorset, BH2 6EZ  
+44 (0) 1202 586200  
Web: www.imagine-publishing.co.uk  
www.retrogamer.net  
www.greatdigitalmags.com

## Magazine team

**Editor Darran Jones**  
retrogamer@imagine-publishing.co.uk  
01202 586237  
**Editor in Chief Ryan King**  
**Senior Designer Jonathan Wells**  
**Staff Writer Nick Thorpe**  
**Production Editor Steve Holmes**  
**Photographer James Sheppard**  
**Senior Art Editor Andy Downes**  
**Publishing Director Aaron Asadi**  
**Head of Design Ross Andrews**

## Contributors

Adam Barnes, Mike Bevan, Richard Burton, Martyn Carroll, David Crookes, Paul Davies, Paul Drury, Marty Goldberg, Jason Kelk, Phil King, Graeme Mason, Rory Milne,

## Advertising

Digital or printed media packs are available on request

**Head of Sales** Hang Deretz  
01202 586442  
hang.deretz@imagine-publishing.co.uk

**Account Manager** Anthony Godsell  
01202 586420  
anthony.godsell@imagine-publishing.co.uk

## International

Retro Gamer is available for licensing. Contact the International department to discuss partnership opportunities.

**Head of International Licensing** Cathy Blackman  
+44 (0) 1202 586401  
licensing@imagine-publishing.co.uk

## Subscriptions

For all subscription enquiries email [retrogamer@servicehelpline.co.uk](mailto:retrogamer@servicehelpline.co.uk)  
(UK) 0844 848 8412  
(Overseas) +44 1795 592 872  
13 issue subscription UK - £51.90  
13 issue subscription Europe - £70  
13 issue subscription ROW - £80

## Circulation

**Head of Circulation** Darren Pearce  
01202 586200

## Production

**Production Director** Jane Hawkins  
01202 586200

## Founders

**Group Managing Director** Damian Butt

## Printing & Distribution

Printed by Wyndeham Heron Ltd, Bentalls Complex, Colchester Road, Heybridge, Maldon, Essex, CM9 4NW  
01621 877 777

Distributed in the UK, Eire & Rest of the World by: Marketforce, Blue Fin Building, 110 Southwark Street, London, SE1 0SU  
0203 148 3300  
www.marketforce.co.uk

Distributed in Australia by: Network Services (a division of Bauer Media Group), Level 21 Civic Tower, 66-68 Goulburn Street, Sydney, New South Wales 2000, Australia  
+61 2 8667 5288

## Disclaimer

The publisher cannot accept responsibility for any unsolicited material lost or damaged in the post. All text and layout is the copyright of Imagine Publishing Ltd. Nothing in this magazine may be reproduced in whole or part without the written permission of the publisher. All copyrights are recognised and used specifically for the purpose of criticism and review. Although the magazine has endeavoured to ensure all information is correct at time of print, prices and availability may change. This magazine is fully independent and not affiliated in any way with the companies mentioned herein. If you submit material to Imagine Publishing via post, email, social network or any other means, you automatically grant Imagine Publishing an irrevocable, perpetual, royalty-free license to use the materials across its entire portfolio, in print, online and digital, and to deliver the materials to existing and future clients, including but not limited to international licensees for reproduction in international, licensed editions of Imagine products. Any material you submit is sent at your risk and, although every care is taken, neither Imagine Publishing nor its employees, agents or subcontractors shall be liable for the loss or damage.

© Imagine Publishing Ltd 2014 ISSN 1742 3155



## STAR LETTER COLLECTING BLUES

Hi RG, I really enjoyed your article on gaming obsessions. For over 20 years I've been collecting Sonic The Hedgehog merchandise and found joy in getting the games, CDs, comics etc. However, recently I've noticed fatigue towards the joy in collecting Sonic items. It could be that there's no end to merchandise, that companies have picked up on collectors' habits and begun releasing multiple variations at increased cost or simply because I'm nearing my thirties and finding interest in other areas, so it's comforting to read that I'm not the only one to feel that way. Five years ago I would've thought nothing on spending hundreds on a statue, but now wonder what benefit I get out

of it. It's an interesting dilemma as I don't regret collecting, but as 90% of my collection resides in an attic until I get more space, I wonder if my hard-earned money could've been better spent elsewhere?  
Benji Copeman

Hi Benji, we think the important thing to remember about collections is the enjoyment you get out of them. We've all had regrets about buying things, but as long as you're actually getting some satisfaction out of your purchases it really shouldn't matter. Take your mind off it with a rather awesome Retro Gamer eMag. PS There are three to collect.



Benji is a huge fan of Sonic. Does anyone have collect specific memorabilia?

[Xbox 360] Worry not, Matthew: it's going to be a long, long time before we cover Gears Of War.

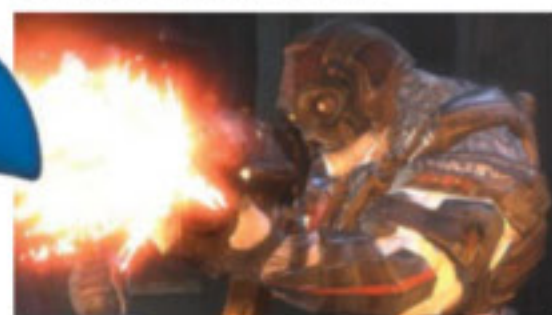

will of course look at doing similar subscription bonuses in the future.

## MASTER GRIEF

Hi Retro Gamer, I nearly spat my tea out when I saw you had covered Halo: Combat Evolved in your latest issue. It was bad enough that those pathetic and decidedly un-retro Pokémon were on the front cover, but your fawning over Halo was completely unacceptable.

There is nothing retro or special about Halo: Combat Evolved. It's on a console that no one cares about; it has rubbish levels and is about as innovative as a hammer blow to the head.

Consoles like the Xbox and GameCube have no place at all in a magazine like Retro Gamer. It's bad enough that you cover 16-bit and 32-bit consoles, so please don't start covering Xbox games. Whatever next? The complete history of Gears Of War? Yours in disbelief,  
Matthew Lightbourne

Sorry you didn't like the Halo feature, Matthew. Unfortunately, we're all getting older, and so too are the games we used to play. While Halo may not be retro to you, it will be to other readers and magazines need to appeal to everyone. Don't worry, though: there's not going to be any Gears Of War coverage for a very long time indeed.

## COIN-OP CONCERNS

Dear RG, I recently read your excellent article about the Rampage franchise. I had fond memories of playing the Spectrum version back in the day, and eagerly flicked through the magazine for the usual conversion capers. Imagine

but it would be great to see the odd article every now and then. Kindest regards,  
Chris James

Hi Chris, glad you're enjoying the magazine. We actually ran a making of Halo: Combat Evolved in our last issue, which you may have seen. We will look at covering these systems in the future, but the focus of the magazine will always be primarily on the 8-bit and 16-bit systems.

## PIKACHU!

Dear Retro Gamer, I just wanted to say how delighted I am to receive my Pikachu subscriber cover. As soon as I saw there was going to be a split-run I was hoping for the Pikachu cover, as he's my favourite Pokémon. Needless to say I was really pleased to get it. I really hope you do similar subscriber promotions in the future.  
Ben Smith

Glad you loved the cover, Ben. It's certainly been a controversial cover and there's been a lot of debate on the forum. We



You can expect more exclusive subscription covers in the future.

## WHERE'S MY XBOX COVERAGE?

Dear Retro Gamer, Why don't the PS2, GameCube and Xbox get enough love in the magazine? They're all over ten years old and at least two generations old, so it seems strange that you don't cover them to any great extent. Granted we'll get the odd Future Classic if we're lucky, but where's the

history of Jak & Daxter, the Making Of Ico or the complete lowdown on the Metroid Prime trilogy?

As a gamer in my thirties, I have fond memories of these consoles and would love to read more information about them in the magazine. I know that some people don't consider these consoles retro, but I do and feel my voice is just as important as everyone else's. I'm not expecting you to swamp the magazine with coverage,



[Xbox] Hopefully Chris James enjoyed our recent Halo article.



## DISCUSSED THIS MONTH

### Remakes

This month our tea breaks have been spent discussing franchises we'd love to see updated. Nick would love a new Burning Rangers with asynchronous gameplay, while Darran is still harping on about Panzer Dragoon Saga 2. Jon, on the other hand, feels that the time is perfect to revisit Tony Hawk's Pro Skater.



## From the forum

>> www.retrogamernet/forum

Every month, Retro Gamer asks a question on the forum and prints the best replies. This month we wanted to know...

## Your favourite Hewson game

### ArchaicKoala

I loved Nebulus so could vote for that, but Paradroid is just too good to miss. Paradroid it is then, as it is the best game out of a list of really great games from one of the best software houses in the '80s.

### The Laird

Has to be Paradroid '90 for me, I enjoyed this game immensely when I very first got my Atari ST.

### Bub&Bob

Paradroid for me - It's pretty much the only C64 game which gets played regularly.

### Ianmarks

Avalon for me. Dragontorc was probably the better game, but

the sheer wonder I felt playing the original for the first time never faded.

### Idanddied

Cybermaid. No. Exalon. No. Marauder. No. Uridium. Firelord! Oh I don't know.

### Antiriad2097

Hewson is one of those signs of quality; you can pick just about any of their games and it'll be among the best of its contemporaries. Personally, I've returned to Gribbly's Special Day Out more than any other. A perfect blend of frustration vs progress, where time invested does pay off.

### markopoloman

I don't know how anyone can pick just one favourite from such a quality line-up. Exalon and Quazatron are amongst the finest games from the whole 8-bit computer era, and Nebulus and Eliminator equally stand out on the 16-bits (which isn't to say their 8-bit versions are anything less than amazing).

### joefish

I loved Hewson games, a real stamp of quality. They made three of my favourite Spectrum games in Zynaps, Cybermaid and Uridium. If I had to pick just one it'd be Zynaps, closely followed by the other two. I had the 4 Smash Hits compilation; it was all killer, no filler. Just feel the quality!

### Hiro

While Paradroid is a masterpiece and Cybermaid 1 & 2, Rubicon and Stormlord are excellent games (all blessed by fantastic music on the C64), Eliminator is my choice. Fun, smooth fake-3D arcade action with an intelligent password system. Great little game.

[Arcade] Jason would like to see conversions in all arcade articles. Does anyone else agree?



convinced that it was an R-Type game, but I told him not to be silly as they never made anything that colourful. Please could you tell us who is right?  
Anthony Baker

Hi Anthony, we'd be happy to settle your argument. We're going to side with your cousin, as we're pretty sure the game you're talking about is R-Type Leo. Hope that solves it.



[Arcade] R-Type Leo's colourful visuals made it stand apart from the other games in the series.

# Magix Buttons

We speak to Steven Saunders about his interesting new website that's a little different to your usual retro gaming emporium

**Tell us a little about Magix Buttons?**

As a company, Magix Buttons was started about two and a half years ago by my colleague Boris Nicolai, but he spend a lot of years before that time collecting retro gaming products of all kinds. We both have a history of serious comic book collecting. After that, he caught on to the increase in value of classic games and consoles, while I was busy simply gaming like a madman and reviewing games for several media outlets, which I still do to this day. A year ago we joined forces, so to speak.

**What was the reason to have your website part shop, part magazine?**

Selling retro games is important to keep the company going and growing, but we are all passionate gamers with a sincere love for the classics. We envision Magix Buttons as a platform that encompasses this feeling and is fun to visit, even if you don't want to buy something. For this reason we try to be present at most events with a booth, regardless whether the focus is retail or entertainment. We have our 'Wall of

Consoles' and custom-built Hyperspin arcade beast we always bring along.

**What do you think Magix Buttons offers over other retro gaming online shops?**

Apart from the aforementioned magazine, we have a seriously impressive inventory. But we don't just offer a huge number of products; we also have some truly exclusive and hard-to-find collectables. And since all people involved in the company genuinely know a lot about retro games, we are able to offer quality customer support and try to be extremely accurate in our product descriptions.

**Why do you sell games from non-PAL regions?**

Despite being based in The Netherlands, we have customers from literally all over the world. We try to cater to every retro gaming collector, no matter where they are from and no matter what they are looking for. And of course, collectors of all nationalities dig the Japanese versions, so we have an

Find out more by visiting [www.magixbuttons.com](http://www.magixbuttons.com)



Steven (right) and Boris at one of the many gaming events they visit.

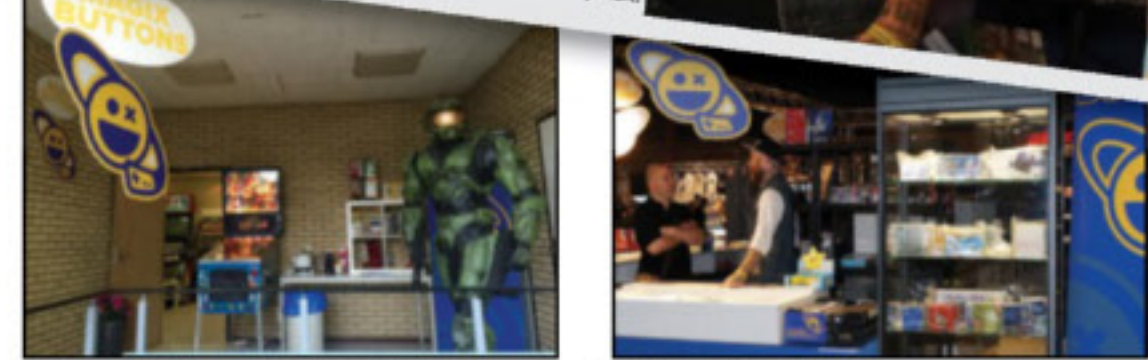

Not every office has cool stuff like this in it. We're actually a little jealous of that pinball table.

**“Basically, we sell anything retro gaming related, to anyone, anywhere”**

Steven Saunders explains what Magix Buttons is all about

especially noteworthy selection of Japanese games in stock. Basically, we sell anything retro gaming related, to anyone, anywhere.

**How do you go about setting your prices?**

We try to be very competitive with our prices, but that goes without saying. We have been following the retro gaming market for many years now, so we have a pretty good grip on what a product is currently worth. We check other web shops and forums too, to make sure we

are on point. On top of that we have monthly discount deals to keep things interesting.

**What areas of gaming sell the best?**

It will come as no surprise that anything Nintendo and Sega related always does well. Titles from their big franchises – such as *Mario Kart*, *The Legend Of Zelda*, *Sonic* and *Shining Force* – never stay in our shop for long. Apart from the old-school platforming games, all the RPGs are extremely popular too and seem to rise in price steadily. Also, out of a personal preference, we have a ludicrous amount of Game & Watch handhelds in our inventory. Most of us started gaming on them a long time ago (longer than we care to admit), so we never pass up on an opportunity to stock up on those.

**How easy is it for gamers to sell games to you?**

We certainly try to make it as easy as possible. We have a special page on our website where people can contact us to let us know what they have for sale. We are always in the market for more inventory – from common retro games and consoles to the more elusive and rare goods. We also believe we make some pretty fair deals, optionally in store credit in case someone is interested in something from our current inventory. \*



Magix Buttons has a huge amount of stock, focusing on Nintendo and Sega.

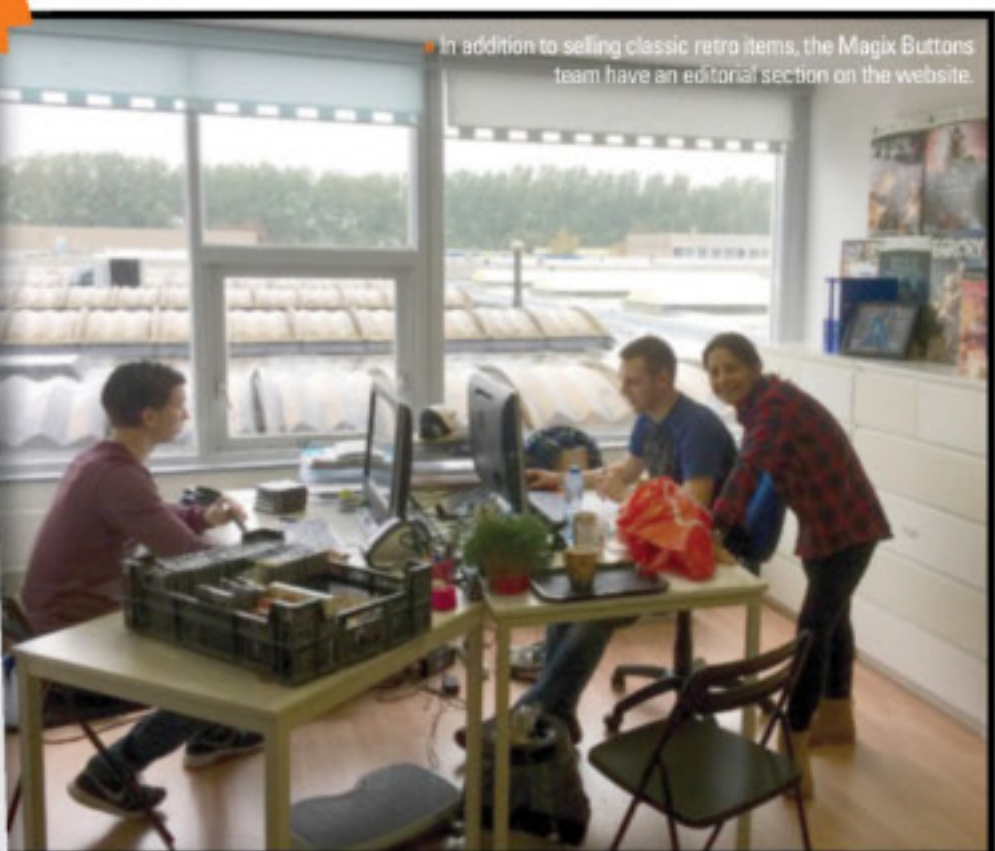

In addition to selling classic retro items, the Magix Buttons team have an editorial section on the website.

20 Years of

# PlayStation

We speak to developers about Sony's groundbreaking move into videogames



**Featured Next Month**

**Dungeons & Dragons**

As the tabletop RPG turns 40 we interview the developers behind the best digital games

**Highway Encounter**

Costa Panayi reveals the origins of his excellent isometric shoot-'em-up

**Pit-Fighter**

Discover how Atari Games created its popular digitised one-on-one fighter

**Combat School**

Our latest Ultimate Guide looks at Konami's military alternative to Hyper Sports

ALSO INSIDE Automata • Commodore 16 Plus/4 • Jez San • Eternal Champions • Shanghai Warriors • Matt Gray



# MUTANT CATERPILLAR GAMES

... SINCLAIR ... COMMODORE ... ACORN ...

**10% OFF** your first order when you use discount code "retrogc1"

MACHINES      REPAIRS

HARDWARE      SOFTWARE

ALL OUR STOCK IS TESTED, WORKING AND GUARANTEED  
 FREE UK inland postage - excellent international postage rates

www: www.mutant-caterpillar.co.uk      email: sales@mutant-caterpillar.co.uk  
 ebay: mutant-caterpillar      tel: 01970 625441

... AMSTRAD ... ATARI ... ANYTHING ELSE!

# RETRO TOWERS.COM

www.retro Towers.co.uk

## EVERDRIVES

Play games on an SD Card with your original systems.

Shop Now      Save 5% Coupon Code: **retrozone**

# CHILLOUT GAMES

we value your games

www.chilloutgames.co.uk/SellGames.aspx

review centre  
 since **1st** 2005

**We Pay:**

<b>£61.08</b>	<b>£22.12</b>	<b>£16.10</b>
<b>£65.84</b>	<b>£16.57</b>	<b>£70.60</b>

**-RAPID PAYMENT**  
**-GREAT PRICES**  
**-FREE COURIER**

**WANTED SECOND HAND**

win prizes facebook

Prices valid as at 3rd December 2014. Prices subject to change on a daily basis. Chillout Games and retro-games.co.uk are trading names of Chillout Games Ltd. Prices are for shop credit - 12% more than PayPal. T&Cs at www.chilloutgames.co.uk.

To advertise in

# retro GAMER

Contact us on  
 01202 586442

adinfo@Imagine-publishing.co.uk

## DIY Mini Arcade Cabinet Kits for Raspberry Pi

www.RetroBuiltGames.com

Raspberry Pi is a trademark of the Raspberry Pi Foundation

# retro gaming cables.co.uk

Quality audio video cables made in Great Britain

RGB SCART Cables available for:

- Sega Mega Drive 1 & 2
- Nintendo SNES (PAL & NTSC)
- SNK Neo Geo AES & CD/CDZ
- BBC Acorn Micro
- Sinclair ZX Spectrum + 128k, +2 & QL
- Atari STF, STE & STFM
- Amstrad CPC 464
- Various Arcade Jamma Superguns (Sigma, Pana, CMVS etc)

Plus many more on our website

RGB SCART cable key features:

- Vast improvement over traditional RF, composite video and s-video
- Pixel clear RGB video
- Improved sound quality
- No more tuning
- SCART TV plug & Play
- Compatible with up-scaling units i.e. Framemeister Mini XRGB

Buy direct from [www.retrogamingcables.co.uk/store](http://www.retrogamingcables.co.uk/store)  
 FREE UK Delivery

# ENDGAME



## METAL GEAR SOLID

» Solid Snake might have spent eight years on the sidelines prior to Metal Gear Solid's release, but you wouldn't have known it – the game was an instant classic, with some incredibly clever game design backed up by the most impressive cinematic scenes of the era. Skip to one of the two lengthy endings with us...



01 Otacon, can you move?

» Having crashed out of the tunnel, Snake and Otacon are alive – but trapped under their overturned Jeep. It's not a great place to be in the frigid Alaskan wilds, and the situation is about to worsen considerably for the pair...



02 ...Snasake...

» Liquid Snake's alive and he's got a gun! Someone's definitely going to die – but in accordance with the Fortuitous Timing Act 1968 it turns out to be Liquid, as the FOXDIE virus takes effect and he succumbs to a massive heart attack.



03

Metal Gear, the training exercise... all of it... It was all the Secretary of Defense acting alone.

» Roy Campbell reveals that US defence chief Jim Houseman was actually acting alone the whole time. Luckily, the nuclear strikes against the island have been called off, ensuring that Snake and Otacon won't be reduced to ashes after all.



04

It's up to you how you use the time left to you.

» But what's to become of Solid Snake? He's infected with FOXDIE too, which means he's going to die at some point. However, Naomi can't tell him when, and simply advises him to live his life as best he can. Cold comfort, given that she was the one who infected him...



05

I want to enjoy life.

» Solid Snake has realised that he's no longer in control of his own survival, and following a long chat with Otacon about genetics and destiny he resolves to simply enjoy life. Finally, the two reveal their real names to one another: Dave and Hal. We're not kidding – that's the closing joke.

THE UK'S BIGGEST MODERN POP CULTURE EVENTS

# MCM COMIC CON

## RETURNING IN 2015



**TELFORD**  
14 FEBRUARY

**BIRMINGHAM**  
21-22 MARCH

**BELFAST**  
4-5 APRIL

**LONDON**  
22-24 MAY

**MANCHESTER**  
25-26 JULY

**DUBLIN**  
29-30 AUGUST

**GLASGOW**  
26-27 SEPTEMBER

**LONDON**  
23-25 OCTOBER

**BIRMINGHAM**  
21-22 NOVEMBER

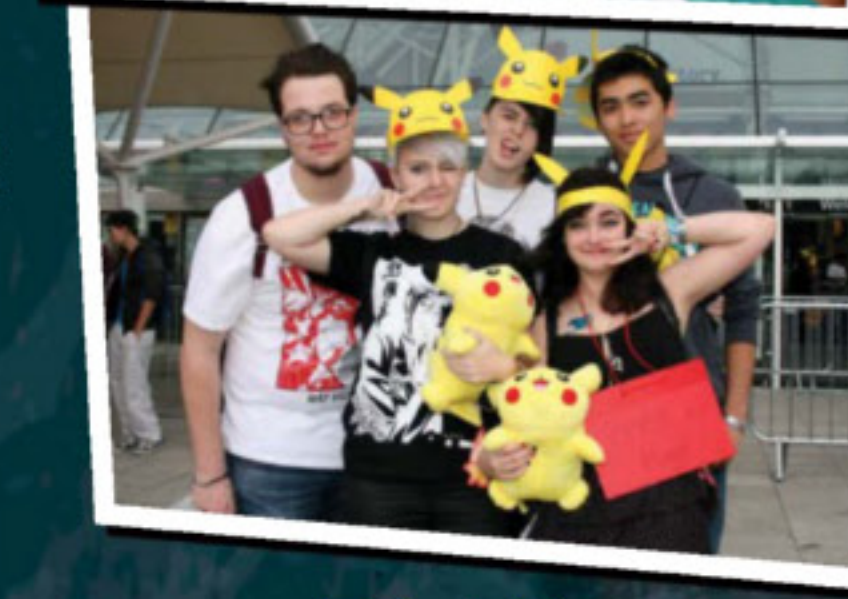

**MCMEXPO**

**BUY TICKETS ONLINE**

COMICS • MANGA • COSPLAY • MOVIES • VIDEO GAMES • ANIME



[WWW.MCMCOMICCON.COM](http://WWW.MCMCOMICCON.COM)

\* Kids Go Free, Children 10 and Under go free if accompanied by a paying adult. Max 2 free children per adult, applies to entry tickets after 11am on each day

# sinclair



**ORDER NOW**  
**ONLY £25.00**

The story of the ZX Spectrum

238 pages of paperback pixel celebration.

A visual journey of the classic ZX Spectrum games from 1982-1990.

With memoirs direct from those who developed games for the ZX Spectrum and one from Rick Dickinson, the designer of each iteration of the computer from the 16K/48K Spectrum through to the Spectrum +3.



Available on iBook  
Bookstore



[facebook.com/groups/spectrumpixels/](https://facebook.com/groups/spectrumpixels/)

# FUSION RETRO BOOKS.com